

# Operating Manual

Translation of the original operating manual

## KB /KB-UL (E7)

## Cooling Incubators

with compressor technology and RD4 controller

Model	Art. No.
KB 65	9020-0471, 9120-0471
KB 65-UL	9020-0491, 9120-0491
KB 130	9020-0472, 9120-0472
KB 130-UL	9020-0500, 9120-0500
KB 260	9020-0473, 9120-0473
KB 260-UL	9020-0501, 9120-0501
KB 470	9020-0474, 9120-0474
KB 470-UL	9020-0502, 9120-0502
KB 720	9020-0475, 9120-0475
KB 720-UL	9020-0503, 9120-0503
KB 1060	9020-0476, 9120-0476
KB 1060-UL	9020-0504, 9120-0504

### **BINDER GmbH**

- ▶ Address: Post office box 102, 78502 Tuttlingen, Germany
- ▶ Phone: +49 7462 2005 0
- ▶ Fax: +49 7462 2005 100
- ▶ Internet: <http://www.binder-world.com>
- ▶ Service Hotline: +49 7462 2005 555
- ▶ Service Fax: +49 7462 2005 93 555
- ▶ Service Hotline USA: +1 866 885 9794 or +1 631 224 4340 x3
- ▶ Service Hotline Asia Pacific: +852 390 705 04 or +852 390 705 03

---

## Content

<b>1. SAFETY</b>	<b>6</b>
1.1 Personnel Qualification	6
1.2 Operating manual	6
1.3 Legal considerations	6
1.3.1 Intellectual property	7
1.4 Structure of the safety instructions in the operating manual	7
1.4.1 Signal word panel	7
1.4.2 Safety alert symbol	8
1.4.3 Pictograms	8
1.4.4 Word message panel structure	9
1.5 Localization / position of safety labels on the chamber	9
1.6 Type plate	10
1.7 UKCA Label	11
1.8 General safety instructions on installing and operating the chambers	12
1.9 Intended use	13
1.10 Foreseeable Misuse	15
1.11 Residual Risks	15
1.12 Operating instructions	17
1.13 Measures to prevent accidents	17
<b>2. CHAMBER DESCRIPTION</b>	<b>18</b>
2.1 Chamber overview	19
2.2 Triangular instrument panel	20
2.3 Control panel on the chamber rear	20
<b>3. COMPLETENESS OF DELIVERY, TRANSPORTATION, STORAGE, AND INSTALLATION</b>	<b>21</b>
3.1 Unpacking, and checking equipment and completeness of delivery	21
3.2 Guidelines for safe lifting and transportation	22
3.3 Storage	22
3.4 Location of installation and ambient conditions	22
<b>4. INSTALLATION AND CONNECTIONS</b>	<b>24</b>
4.1 Spacer for wall distance (from size 260 on)	24
4.2 Mounting the flexible tilt protection kit (KB/KB-UL 65, 130, 470)	25
4.3 Condensate collection pan	26
4.4 Racks with U-rails or with telescopic rails (accessory)	26
4.5 Electrical connection	27
<b>5. FUNCTIONAL OVERVIEW OF THE RD4 CHAMBER CONTROLLER</b>	<b>28</b>
5.1 Menu structure of the controller and access levels	29
5.2 Performance during and after power failures	30
<b>6. START UP</b>	<b>30</b>
<b>7. SET-POINT ENTRY</b>	<b>31</b>
7.1 Temperature set-point entry	31
7.2 Fan speed set-point entry	31
<b>8. SETTING SPECIAL CONTROLLER FUNCTIONS</b>	<b>32</b>
<b>9. AUTOMATIC SETPOINT SWITCHOVER</b>	<b>33</b>
9.1 Control by date	34
9.2 Regular cyclic control	36
9.3 Entry of the alternative temperature set-point	37
9.4 Activating / deactivating special controller functions	37

<b>10. HOT-AIR DISINFECTION</b> .....	<b>38</b>
10.1 Preparations .....	38
10.2 Starting the hot-air disinfection.....	38
10.3 Hot air disinfection process .....	39
10.4 Completing the hot-air disinfection.....	39
10.5 Prematurely terminating the hot-air disinfection.....	40
<b>11. PASSWORD</b> .....	<b>40</b>
11.1 Password request .....	40
11.2 Assign and modify a password .....	41
11.2.1 Assign and modify the User password .....	41
11.2.2 Assign and modify the Admin password.....	42
<b>12. TEMPERATURE SAFETY DEVICES</b> .....	<b>42</b>
12.1 Over temperature protective device (class 1) .....	42
12.2 Safety controller class 2 / class 3.3.....	42
12.2.1 Selecting between safety controller class 2 (temperature limiter) or class 3.3 (temperature protection) .....	44
12.2.2 Safety controller mode .....	44
12.2.3 Setting the safety controller mode .....	45
12.2.4 Setting the safety controller Limit value for overtemperature .....	45
12.2.5 Setting the safety controller Offset value for over- and undertemperature.....	46
12.3 Safety controller class 3.2 (undertemperature protection).....	46
12.3.1 Setting the safety controller value for undertemperature protection with safety controller mode "Limit" .....	46
12.4 Message and measures in the state of alarm .....	47
12.5 Function check .....	47
<b>13. GENERAL CONTROLLER SETTINGS</b> .....	<b>48</b>
13.1 Selecting the controller's menu language .....	48
13.2 Selecting the temperature unit .....	48
13.3 Setting the current date.....	49
13.4 Setting the current time .....	49
13.5 Function "Language selection at restart" .....	50
13.6 Setting the chamber address .....	50
13.7 Display brightness.....	51
<b>14. TOLERANCE RANGE SETTINGS</b> .....	<b>51</b>
14.1 Setting the delay time for tolerance range alarm .....	51
14.2 Setting the temperature tolerance range .....	52
<b>15. NOTIFICATION AND ALARM FUNCTIONS</b> .....	<b>52</b>
15.1 Information messages.....	52
15.2 Alarm messages .....	53
15.3 Activating / deactivating the audible alarm (alarm buzzer) .....	54
<b>16. ETHERNET NETWORK SETTINGS</b> .....	<b>55</b>
16.1 Showing the network settings .....	55
16.1.1 Showing the chamber's MAC address.....	55
16.1.2 Showing the IP address .....	55
16.1.3 Showing the subnet mask.....	56
16.1.4 Showing the standard gateway.....	56
16.1.5 Showing the DNS server address.....	56
16.1.6 Showing the DNS chamber name .....	57
16.2 Changing the configuration of the network settings.....	57
16.2.1 Selecting the type of IP address assignment (automatic / manual) .....	57
16.2.2 Selecting the type of assignment of the DNS server address (automatic / manual) .....	58
16.2.3 Assigning the IP address .....	58
16.2.4 Setting the subnet mask .....	59

16.2.5	Setting the standard gateway .....	59
16.2.6	Assigning the DNS server address .....	60
<b>17.</b>	<b>DATA RECORDER .....</b>	<b>60</b>
17.1	Recorded data .....	60
17.2	Storage capacity .....	61
17.3	Setting the storage rate for the "DL1" recorder data .....	61
17.4	Deleting the data recorder .....	61
<b>18.</b>	<b>USB MENU: DATA TRANSFER VIA USB INTERFACE .....</b>	<b>62</b>
18.1	Connecting the USB stick .....	62
18.2	Import function .....	62
18.3	Export functions .....	63
18.4	Ongoing data transfer .....	63
18.5	Error during data transmission .....	63
18.6	Removing the USB stick .....	64
<b>19.</b>	<b>SELF-TEST FUNCTION .....</b>	<b>64</b>
19.1	Activating the self-test function .....	64
19.2	Deactivating the self-test mode .....	65
<b>20.</b>	<b>DEFROSTING AT REFRIGERATING OPERATION .....</b>	<b>66</b>
<b>21.</b>	<b>ANTI-CONDENSATION PROTECTION .....</b>	<b>66</b>
<b>22.</b>	<b>OPTIONS AND ACCESSORIES .....</b>	<b>67</b>
22.1	APT-COM™ 4 Multi Management Software (accessory) .....	67
22.2	Analog outputs for temperature (option) .....	67
22.3	Zero-voltage alarm contacts for collective alarm output (option) .....	67
22.4	Door lock (option) .....	68
22.5	Internal LED light (option) .....	69
22.6	Object temperature control with flexible Pt 100 temperature sensor (option) .....	70
22.6.1	Activating/deactivating object temperature control .....	70
22.6.2	Setting the sensitivity of the object temperature control .....	71
22.6.3	Setting the maximum deviation .....	71
<b>23.</b>	<b>CLEANING AND DECONTAMINATION .....</b>	<b>72</b>
23.1	Cleaning .....	72
23.2	Decontamination / chemical disinfection .....	73
23.3	Hot-air disinfection .....	74
<b>24.</b>	<b>MAINTENANCE AND SERVICE, TROUBLESHOOTING, REPAIR, TESTING... 75</b>	
24.1	General information, personnel qualification .....	75
24.2	Maintenance intervals, service .....	75
24.3	Service Reminder .....	76
24.4	Simple troubleshooting .....	76
24.5	Sending the chamber back to BINDER GmbH .....	78
<b>25.</b>	<b>DISPOSAL .....</b>	<b>79</b>
25.1	Disposal of the transport packing .....	79
25.2	Decommissioning .....	79
25.3	Disposal of the chamber in the Federal Republic of Germany .....	79
25.4	Disposal of the chamber in the member states of the EU except for the Federal Republic of Germany .....	80
25.5	Disposal of the chamber in non-member states of the EU .....	82
<b>26.</b>	<b>TECHNICAL DESCRIPTION .....</b>	<b>82</b>
26.1	Factory calibration and adjustment .....	82
26.2	Over current protection .....	82
26.3	Definition of usable volume .....	82



---

26.4	KB / KB-UL Technical Data.....	83
26.5	Equipment and options (extract) .....	85
26.6	Accessories and spare parts (extract) .....	85
26.7	Dimensions.....	87
<b>27.</b>	<b>CERTIFICATES AND DECLARATIONS OF CONFORMITY.....</b>	<b>93</b>
27.1	EU Declaration of Conformity.....	93
27.2	UKCA Declaration of Conformity .....	96
27.3	Certificate for the GS mark of conformity of the “Deutsche Gesetzliche Unfallversicherung e.V.” (German Social Accident Insurance) DGUV .....	97
<b>28.</b>	<b>CONTAMINATION CLEARANCE CERTIFICATE .....</b>	<b>99</b>
28.1	For chambers located outside USA and Canada .....	99
28.2	For chambers located in USA and Canada .....	102

Dear customer,

For the correct operation of the chambers, it is important that you read this operating manual completely and carefully and observe all instructions as indicated. Failure to read, understand and follow the instructions may result in personal injury. It can also lead to damage to the chamber and/or poor equipment performance.

## 1. Safety

### 1.1 Personnel Qualification



The chamber must only be installed, tested, and started up by personnel qualified for assembly, startup, and operation of the chamber. Qualified personnel are persons whose professional education, knowledge, experience and knowledge of relevant standards allow them to assess, carry out, and identify any potential hazards in the work assigned to them. They must have been trained and instructed, and be authorized, to work on the chamber and must have knowledge of the operating instructions.

The chamber should only be operated by laboratory personnel especially trained for this purpose and familiar with all precautionary measures required for working in a laboratory. Observe the national regulations on minimum age of laboratory personnel.

### 1.2 Operating manual

This operating manual is part of the components of delivery. Always keep it handy for reference in the vicinity of the chamber. If selling the unit, hand over the operating manual to the purchaser.

To avoid injuries and damage observe the safety instructions of the operating manual. Failure to follow instructions and safety precautions can lead to significant risks.

	<div data-bbox="391 1099 1495 1182" style="background-color: red; color: white; text-align: center;"> <b>DANGER</b></div> <p><b>Dangers due to failure to observe the instructions and safety precautions.</b> <b>Serious injuries and chamber damage. Risk of death.</b></p> <ul style="list-style-type: none"><li>➤ Observe the safety instructions in this Operating Manual.</li><li>➤ Follow the operating procedures in this Operating Manual.</li><li>➤ Carefully read the complete operating instructions of the chamber prior to installing and using the chamber.</li><li>➤ Keep the operating manual for future reference</li></ul>
---	--

	Make sure that all persons who use the chamber and its associated work equipment have read and understood the Operating Manual.
---	---

This Operating Manual is supplemented and updated as needed. Always use the most recent version of the Operating Manual. When in doubt, call the BINDER Service Hotline for information on the up-to-date-ness and validity of this Operating Manual.

### 1.3 Legal considerations

This operating manual is for informational purposes only. It contains information for correct and safe installing, start-up, operation, decommissioning, cleaning and maintenance of the product. Note: the contents and the product described are subject to change without notice.

Understanding and observing the instructions in this operating manual are prerequisites for hazard-free use and safety during operation and maintenance. Images are to provide basic understanding. They may deviate from the actual version of the chamber. The actual scope of delivery can, due to optional or special design, or due to recent technical changes, deviate from the information and illustrations in these instructions this operating manual. In no event shall BINDER be held liable for any damages, direct or incidental arising out of or related to the use of this manual.

This operating manual cannot cover all conceivable applications. If you would like additional information, or if special problems arise that are not sufficiently addressed in this manual, please ask your dealer or contact us directly, e.g. by phone at the number located on page one of this manual

Furthermore, we emphasize that the contents of this operating manual are not part of an earlier or existing agreement, description, or legal relationship, nor do they modify such a relationship. All obligations on the part of BINDER derive from the respective purchase contract, which also contains the entire and exclusively valid statement of warranty administration and the general terms and conditions, as well as the legal regulations valid at the time the contract is concluded. The statements in this manual neither augment nor restrict the contractual warranty provisions.

### 1.3.1 Intellectual property

**This operating manual is protected by copyright. Any unauthorized copying or disclosure to third parties is strictly prohibited. We reserve the right to take legal action and, if necessary, to assert claims for damages in the event of infringement.**

**Trademark Information:** All BINDER trademarks relating to products or service, as well as trade names, logos and product names used on the website, products and documents of BINDER company are trademarks or registered trademarks of BINDER company (including BINDER GmbH, BINDER Inc.) in the U.S. and other countries and communities of states. This includes word marks, position marks, word/figurative marks, design configurations, figurative marks, and design patents.

**Patent Information:** BINDER products, categories of products, and accessories may be covered by one or more patents and/or utility models in the U.S. and other countries and communities of states. This information is provided to satisfy the virtual patent marking provisions of various jurisdictions, in particular it is intended to serve as notice under 35 U.S.C. § 287(a). Products and services listed on the BINDER website may be sold individually or as part of a combination product. Additional patent applications may also be pending in the U.S. and other countries and communities of states.

Please visit [www.binder-world.com](http://www.binder-world.com) for more information.

## 1.4 Structure of the safety instructions in the operating manual

In this operating manual, the following safety definitions and symbols indicate dangerous situations following the harmonization of ISO 3864-2 and ANSI Z535.6.

### 1.4.1 Signal word panel

Depending on the probability of serious consequences, potential dangers are identified with a signal word, the corresponding safety color, and if appropriate, the safety alert symbol.

 <b>DANGER</b>
Indicates an imminently hazardous situation that, if not avoided, will result in death or serious (irreversible) injury.

 <b>WARNING</b>
Indicates a potentially hazardous situation which, if not avoided, could result in death or serious (irreversible) injury.

 <b>CAUTION</b>
Indicates a potentially hazardous situation which, if not avoided, may result in moderate or minor (reversible) injury.

## NOTICE

Indicates a potentially hazardous situation which, if not avoided, may result in damage to the product and/or its functions or of a property in its proximity.

### 1.4.2 Safety alert symbol



Use of the safety alert symbol indicates a **risk of injury**.

Observe all measures that are marked with the safety alert symbol in order to avoid death or injury.

### 1.4.3 Pictograms

Warning signs			
Electrical hazard	Hot surface	Explosive atmosphere	Stability hazard
Lifting hazard	Risk of corrosion and / or chemical burns	Harmful substances	Biohazard
Pollution Hazard			
Mandatory action signs			
Mandatory regulation	Read operating instructions	Disconnect the power plug	Lift with several persons
Lift with mechanical assistance	Environment protection	Wear protective gloves	Wear safety goggles
Prohibition signs			
Do NOT touch	Do NOT spray with water	Do NOT climb	



**Information** to be observed in order to ensure optimum function of the product.

### 1.4.4 Word message panel structure

**Type / cause of hazard.**





**Possible consequences.**

- ∅ Instruction how to avoid the hazard: prohibition
- Instruction how to avoid the hazard: mandatory action.

Observe all other notes and information not necessarily emphasized in the same way, in order to avoid disruptions that could result in direct or indirect injury or property damage.

### 1.5 Localization / position of safety labels on the chamber

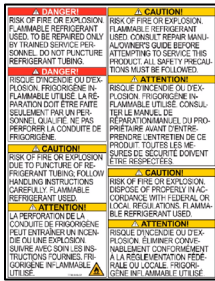
The following labels are located on the chamber:

Pictograms (warning signs)	
	Hot surface (inner glass door above the glass door handle)
	Flammable refrigerants (on chamber rear and type plate)
	<p>Risk of injury.</p> <p>Observe the safety instructions in the operating manual.</p> <p>(on chamber front and type plate)</p>
	
<p><b>Information</b></p> <div style="display: flex; align-items: center; justify-content: space-between;"> <div style="text-align: center;">   <p style="font-size: small;">MySupport.binder-world.com</p> </div> <div style="text-align: center;"> <p>QR-Code and URL to contact the BINDER Support Center</p> </div> </div>	



Keep safety labels complete and legible.

Replace safety labels that are no longer legible. Contact BINDER Service for these replacements.

## 1.6 Type plate

The type plate sticks to the left side of the chamber, bottom right-hand.



Figure 1: Type plate (example KB 260 regular chamber 9020-0473)









Figure 2: Type plate (example KB 260-UL regular chamber 9020-0501)

### Indications of the type plate (example)

Indication		Information
BINDER		Manufacturer: BINDER GmbH
KB 260		Model designation
Cooling incubator		Device name
Serial No.	00000000000000	Serial no. of the chamber
Built	2024	Year of construction
Nominal temperature	100 °C / 212 °F	Nominal temperature
IP protection	20	IP type of protection acc. to standard EN 60529
Temp. safety device	DIN 12880	Temperature safety device acc. to standard DIN 12880:2007
Class	2/3.3	Class of temperature safety device (adjustable)
Art. No.	9020-0473	Art. no. of the chamber
Project No.	---	Optional: Special application acc. to project no.
1,30 kW		Nominal power
5,4 A		Nominal current
220-240 V, 50 Hz		Nominal voltage range +/-10% at the indicated power frequency
220-240 V, 60 Hz		
1 N ~		Current type
Max. operating pressure 11 bar		Max. permissible operating overpressure in the refrigerating system
R600A – 0,095 kg		Refrigerant type and filling weight
Contains hydrocarbon gases		Information on hydrocarbon gases
Unit intended for commercial, Industrial, institutional use acc. ASHRAE 15		Intended for use in commercial, industrial, or institutional occupancies as defined in the Safety Standard for Refrigeration Systems, ASHRAE 15

### Symbols on the type plate

Symbol	Valid for	Information
	All chambers	CE conformity marking
	All chambers	Electrical and electronic equipment manufactured / placed on the market in the EU after 13 August 2005 and be disposed of in separate collection according to Directive 2012/19/EU on waste electrical and electronic equipment (WEEE).
	All chambers	GS mark of conformity of the "Deutsche Gesetzliche Unfallversicherung e.V. (DGUV), Prüf- und Zertifizierungsstelle Nahrungsmittel und Verpackung im DGUV Test" (German Social Accident Insurance (DGUV), Testing and Certification Body for Foodstuffs and Packaging Industry in DGUV Test).
	KB-UL	The chamber is certified by Intertek according to the following standards: <ul style="list-style-type: none"> <li>• IEC 61010-1:2010+A1:2016</li> <li>• IEC 61010-2-012:2019 Ed.2</li> <li>• UL 61010-1:2012 Ed.3+R:06Jun2023</li> <li>• CSA C22.2 No. 61010-1-12:2012 Ed.3+U1;U2;A1;U3]</li> <li>• UL 61010-2-012:2022 Ed.2</li> <li>• CSA C22.2 No. 61010-2-012:2019 Ed.2</li> </ul>
	All chambers	Observe the safety instructions in the operating manual
	All chambers	Flammable refrigerants

### 1.7 UKCA Label

The sticker with UKCA Authorised Representative details sticks next to the type plate to the left side of the chamber, bottom right-hand.



Figure 3: UKCA Label

### Symbol on the sticker

Symbol	Applies to	Information
	All models except KB-UL	UKCA conformity marking

## 1.8 General safety instructions on installing and operating the chambers



With regard to operating the chambers and to the installation location, please observe the local and national regulations relevant for your country (for Germany: DGUV guidelines 213-850 on safe working in laboratories, issued by the employers' liability insurance association).

BINDER GmbH is only responsible for the safety features of the chamber provided skilled electricians or qualified personnel authorized by BINDER perform all maintenance and repair, and if components relating to chamber safety are replaced in the event of failure with original spare parts.



To operate the chamber, use only original BINDER accessories or accessories from third-party suppliers authorized by BINDER. The user is responsible for any risk caused by using unauthorized accessories.

	NOTICE
	<p><b>Danger of overheating due to lack of ventilation.</b>  <b>Damage to the chamber.</b></p> <ul style="list-style-type: none"> <li>⊘ Do NOT install the chamber in unventilated recesses.</li> <li>➤ Ensure sufficient ventilation for dispersal of the heat.</li> <li>➤ Observe the prescribed minimum distances when installing the chamber (chap. 3.4)</li> </ul>

Do not install or operate the chamber in hazardous locations.

	 <b>DANGER</b>
	<p><b>Danger of explosion due to combustible dusts or explosive mixtures in the vicinity of the chamber.</b>  <b>Serious injury or death from burns and / or explosion pressure.</b></p> <ul style="list-style-type: none"> <li>⊘ Do NOT operate the chamber in potentially explosive areas.</li> <li>➤ KEEP combustible dust or air-solvent mixtures AWAY from the chamber.</li> </ul>

The chamber does not dispose of any measures of explosion protection.

	 <b>DANGER</b>
	<p><b>Danger of explosion due to introduction of flammable or explosive substances in the chamber.</b>  <b>Serious injury or death from burns and / or explosion pressure.</b></p> <ul style="list-style-type: none"> <li>⊘ Do NOT introduce any substance into the chamber which is combustible or explosive at working temperature.</li> <li>⊘ Do NOT introduce any combustible dust or air-solvent mixture in the inner chamber.</li> </ul>

Any solvent contained in the loading material must not be explosive or inflammable. I.e., irrespective of the solvent concentration in the steam room, NO explosive mixture with air must form. The temperature inside the chamber must lie below the flash point or below the sublimation point of the loading material. Familiarize yourself with the physical and chemical properties of the loading material, as well as the contained moisture constituent and its behavior with the addition of heat energy.



Familiarize yourself with any potential health risks caused by the loading material, the contained moisture constituent or by reaction products that may arise during the temperature process. Take adequate measures to exclude such risks prior to putting the chamber into operation.





	 <b>DANGER</b>
	<p><b>Electrical hazard by water entering the chamber.</b>  <b>Deadly electric shock.</b></p> <ul style="list-style-type: none"> <li>∅ The chamber must NOT become wet during operation, cleaning, or maintenance.</li> <li>∅ Do NOT install the chamber in damp areas or in puddles.</li> <li>➤ Set up the chamber so that it is splash-proof.</li> </ul>

The chambers were produced in accordance with VDE regulations and were routinely tested in accordance to VDE 0411-1 (IEC 61010-1).

During and shortly after operation, the temperature of the inner surfaces almost equals the set-point. The inner chamber will become hot during operation.

	 <b>CAUTION</b>
	<p><b>Danger of burning by touching hot chamber parts during operation.</b>  <b>Burns.</b></p> <ul style="list-style-type: none"> <li>∅ Do NOT touch the inner surfaces or the loading material during operation.</li> </ul>

	 <b>WARNING</b>
	<p><b>Danger of injury and damages by the chamber tipping over or breakaway of the protruding lower housing cover.</b>  <b>Injuries and damage to the chamber and the loading material.</b></p> <ul style="list-style-type: none"> <li>∅ Do NOT load the lower housing cover with heavy objects while the chamber door is open and do NOT climb on it.</li> </ul>

## 1.9 Intended use

	<p>Following the instructions in this operating manual and conducting regular maintenance work (chap. 24) are part of the intended use.</p>
---	---

**Any use of the chambers that does not comply with the requirements specified in this Operating Manual shall be considered improper use.**

**Other applications than those described in this chapter are not approved.**

### Use

Cooling incubators KB / KB-UL are suitable for exact conditioning of harmless materials. Because of their precise temperature accuracy these devices are especially useful for cultivation of microorganisms with a narrow temperature optimum in a range of 4 °C / 39.2 °F to 37 °C / 98.6 °F. Main fields of application are tests of long-term storage (e.g. at 4 °C / 39.2 °F), refrigerated incubation between 20 °C / 68 °F and 25 °C / 77 °F and incubation at 37 °C / 98.6 °F (also with additional introduction of heat) or with alternating temperatures (e.g. 37 °C / 98.6 °F and 4 °C / 39.2 °F).



Cooling incubators KB-UL are intended for use in commercial, industrial, or institutional occupancies as defined in the Safety Standard for Refrigeration Systems, ASHRAE 15.

### Requirements for the chamber load



Any solvent must not be explosive and flammable. A mixture of any component of the loading material with air must NOT be explosive. The operating temperature must lie below the flash point or below the sublimation point of the loading material. Any component of the loading material must NOT be able to release toxic gases.

The loading material shall not contain any corrosive ingredients that may damage the machine components made of stainless steel, aluminum, and copper. Such ingredients include in particular acids and halides. Any corrosive damage caused by such ingredients is excluded from liability by BINDER GmbH.

The chamber does not dispose of any measures of explosion protection.

 	 <b>DANGER</b>
	<p><b>Explosion or implosion hazard and danger of poisoning through the introduction of unsuitable loading material.</b></p> <p><b>Poisoning. Serious injury or death from burns and / or explosion pressure.</b></p> <ul style="list-style-type: none"> <li>⊘ Do NOT introduce any substance combustible or explosive at working temperature into the chamber, in particular no energy sources such as batteries or lithium-ion batteries.</li> <li>⊘ NO explosive dust or air-solvent mixture in the inner chamber.</li> <li>⊘ Do NOT introduce any substance which could lead to release of toxic gases.</li> </ul>

Contamination of the chamber by toxic, infectious or radioactive substances must be prevented.

 	 <b>WARNING</b>
	<p><b>Danger of intoxication and infection through contamination of the chamber with toxic, infectious or radioactive substances.</b></p> <p><b>Damages to health.</b></p> <ul style="list-style-type: none"> <li>➤ Protect the interior of the chamber from contamination by toxic, infectious or radioactive substances.</li> <li>➤ Take suitable protective measures when introducing and removing toxic, infectious or radioactive material</li> </ul>

In case of foreseeable use of the chamber there is no risk for the user through the integration of the chamber into systems or by special environmental or operating conditions in the sense of EN 61010-1:2010. For this, the intended use of the chamber and all its connections must be observed.

### Medical devices

The chambers are not classified as medical devices as defined by Regulation (EU) No 2017/745.

	<p>Due to the special demands of the Medical Products legislation, these chambers are not qualified to perform sterilization of medical devices as defined by Regulation (EU) No 2017/745.</p>
---	--

### Personnel Requirements

Only trained personnel with knowledge of the Operating Manual can set up and install the chamber, start it up, operate, clean, and take it out of operation. Service and repairs call for further technical requirements (e.g. electrical know-how), as well as knowledge of the service manual.

### Installation site requirements

The chambers are designed for setting up inside a building (indoor use).

The requirements described in the Operating Manual for installation site and ambient conditions (Chap. 3.4) must be met.

	<p><b>WARNING:</b> If customer should use a BINDER chamber running in non-supervised continuous operation, we strongly recommend in case of inclusion of irrecoverable specimen or samples to split such specimen or samples and store them in at least two chambers, if this is feasible.</p>
---	--

## 1.10 Foreseeable Misuse

Other applications than those described in chap. 1.9 are not approved.

This expressly includes the following misuses (the list is not exhaustive), which pose risks despite the inherently safe construction and existing technical safety equipment:

- Non-observance of Operating Manual
- Non-observance of information and warnings on the chamber (e.g. control unit messages, safety identifiers, warning signals)
- Installation, startup, operation, maintenance and repair by untrained, insufficiently qualified, or unauthorized personnel
- Missed or delayed maintenance and testing
- Non-observance of traces of wear and tear
- Insertion of materials excluded or not permitted by this Operating Manual.
- Non-compliance with the admissible parameters for processing the respective material.
- Installation, testing, service or repair in the presence of solvents
- Installation of replacement parts and use of accessories and operating resources not specified and authorized by the manufacturer
- Installation, startup, operation, maintenance or repair of the chamber in absence of operating instructions
- Bypassing or changing protective systems, operation of the chamber without the designated protective systems
- Non-observance of messages regarding cleaning and disinfection of the chamber.
- Spilling water or cleaning agent on the chamber, water penetrating into the chamber during operation, cleaning or maintenance.
- Cleaning activity while the chamber is turned on.
- Operation of the chamber with a damaged housing or damaged power cord
- Continued operation of the chamber during an obvious malfunction
- Insertion of objects, particularly metallic objects, in louvers or other openings or slots on the chamber
- Human error (e.g. insufficient experience, qualification, stress, exhaustion, laziness)

To prevent these and other risks from incorrect operation, the operator shall issue operating instructions. Standard operating procedures (SOPs) are recommended.

## 1.11 Residual Risks

The unavoidable design features of a chamber, as well as its proper field of application, can also pose risks, even during correct operation. These residual risks include hazards which, despite the inherently safe design, existing technical protective equipment, safety precautions and supplementary protective measures, cannot be ruled out.

Messages on the chamber and in the Operating Manual warn of residual risks. The consequences of these residual risks and the measures required to prevent them are listed in the Operating Manual. Moreover, the operator must take measures to minimize hazards from unavoidable residual risks. This includes, in particular, issuing operating instructions.

The following list summarizes the hazards against which this Operating Manual and the Service Manual warn, and specifies protective measures at the appropriate spots:

### **Unpacking, Transport, Installation**

- Sliding or tilting the chamber
- Setup of the chamber in unauthorized areas
- Installation of a damaged chamber
- Installation of a chamber with damaged power cord
- Inappropriate site of installation
- Missing protective conductor connection

### **Normal operation**

- Assembly errors
- Contact with hot surfaces on the housing
- Contact with hot surfaces in the interior and inside of doors
- Emission of non-ionizing radiation from electrical operating resources
- Contact with live parts in normal state

### **Cleaning and Decontamination**

- Penetration of water into the chamber
- Inappropriate cleaning and decontamination agents
- Enclosure of persons in the interior

### **Malfunction and Damage**

- Continued operation of the chamber during an obvious malfunction or outage of the heating or cooling system
- Contact with live parts during error status
- Operation of a unit with damaged power cord

### **Maintenance**

- Maintenance work on live parts.
- Execution of maintenance work by untrained/insufficiently qualified personnel
- Electrical safety analysis during annual maintenance not performed

### **Trouble-shooting and Repairs**

- Non-observance of warning messages in the Service Manual
- Trouble-shooting of live parts without specified safety measures
- Absence of a plausibility check to rule out erroneous inscription of electrical components
- Performance of repair work by untrained/insufficiently qualified personnel
- Inappropriate repairs which do not meet the quality standard specified by BINDER
- Use of replacement parts other than BINDER original replacement parts
- Electrical safety analysis not performed after repairs

## 1.12 Operating instructions

Depending on the application and location of the chamber, the operator of the chamber must provide the relevant information for safe operation of the chamber in a set of operating instructions.



Keep these operating instructions with the chamber at all times in a place where they are clearly visible. They must be comprehensible and written in the language of the employees.

## 1.13 Measures to prevent accidents

The operator of the chamber must observe the local and national regulations (for Germany: the rule “Operation of work equipment. Operation of refrigeration systems, heat pumps and refrigeration equipment”, GUV-R 500 chap. 2.35) and take precautions to prevent accidents.

The manufacturer took the following measures to prevent ignition and explosions:

- **Indications on the type plate**

See operating manual chap. 1.6.

- **Operating manual**

An operating manual is available for each chamber.

- **Overtemperature monitoring**

The chamber is equipped with a temperature display, which can be read from outside.

The chamber is equipped with an additional safety controller (temperature safety device class 2/3.3 (adjustable) acc. to DIN 12880:2007. Visual and audible (buzzer) signals indicate temperature exceeding.

- **Safety, measurement, and control equipment**

The safety, measuring, and control equipment is easily accessible.

- **Electrostatic charge**

The interior parts are grounded.

- **Non-ionizing radiation**

Non-ionizing radiation is not intentionally produced, but released only for technical reasons by electrical equipment (e.g. electric motors, power cables, solenoids). The machine has no permanent magnets. If persons with active implants (e.g. pacemakers, defibrillators) keep a safe distance (distance of field source to implant) of 30 cm, an influence of these implants can be excluded with high probability.

- **Protection against touchable surfaces**

Tested according to EN ISO 13732-1:2008.

- **Floors**

See operating manual chap. 3.4 for correct installation

- **Cleaning**

See operating manual chap. 23.

- **Examinations**

The chamber has been inspected by the “Deutsche Gesetzliche Unfallversicherung e.V. (DGUV) (German Social Accident Insurance (DGUV))” (German Social Accident Insurance (DGUV), Testing and Certification Body for Foodstuffs and Packaging Industry in DGUV Test) and bears the GS mark.

KB-UL only: The chamber is certified by Intertek according to the following standards: IEC 61010-1:2010+A1:2016, IEC 61010-2-012:2019 Ed.2, UL 61010-1:2012 Ed.3+R:06Jun2023, CSA C22.2 No. 61010-1-12:2012 Ed.3+U1;U2;A1;U3, UL 61010-2-012:2022 Ed.2, CSA C22.2 No. 61010-2-012:2019 Ed.2 and bears the ETL mark.

## 2. Chamber description

A high level of precision, reliability, and safety for all growth parameters ensures optimum incubation conditions. Moreover, the KB / KB-UL cooling incubator is designed for maximum usability – even in continuous operation year after year. It fulfills all technical and application-specific requirements arising in experimentation such as in the areas of biotechnology, medicine, the nutrition industry, pharmaceutical and cosmetics industries, botany, and zoology.

Two important temperature technologies have been combined to achieve perfect temperature control. The specially developed indirect cooling process with frequency-controlled compressor in conjunction with the APT.line™ preheating chamber technology, satisfies the unique prerequisites for attaining highly-precise temperature control and particularly short recovery times after opening the door.

### Heater:

The APT.line™ preheating chamber system ensures high level of spatial and time-based temperature precision, thanks to the direct and distributed air circulation into the interior. This is especially important for maintaining temperatures – especially with full chambers – and for rapid restoration of optimum growth conditions after opening the door. The inner glass door ensures that the temperature remains constant when observing the incubation process. The fan supports exact attainment and maintenance of the desired temperature accuracy. The fan speed is digitally adjustable from 40 % to 100 %. The heating and refrigerating systems are microprocessor regulated to a tenth of a degree. In addition, the chamber provides almost unlimited possibilities for adaptation to individual customer requirements based upon extensive programming options and real time clock of the controller.

Hot air disinfection can be carried out at 100 °C / 212 °F.

The chambers are equipped with a door surface heating and chamber edge heating.

**Refrigerating system:** The refrigerating system is distinguished by precise, and rapid temperature conduction with low energy consumption.

Operation is environmentally friendly using a non-climate-damaging hydrocarbon refrigerant.

**Material:** The inner chamber, the pre-heating chamber and the interior side of the doors are all made of stainless steel V2A (German material no. 1.4016, US equivalent AISI 430 and material no. 1.4509, US equivalent AISI 441). The housing is RAL 9003 powder-coated. All corners and edges are also completely coated.

The chamber is provided with an efficient insulation by direct foaming of the chamber with the housing: HIT Insulation® (Housing Injection Technology). This technology also offers high housing stability.

All chamber functions are easy and comfortable to use thanks to their clear arrangement. Major features are easy cleaning of all chamber parts and avoidance of undesired contamination.

**Controller:** KB / KB-UL cooling incubators are equipped with a microprocessor controller for temperature with a digital display accurate to one-tenth of a degree

**Controller:** The efficient RD4 chamber controller is equipped with a multitude of operating functions, in addition to recorder and alarm functions. Set-point entry is easily accomplished directly via the chamber controller and is also possible directly with a computer via Intranet in connection with the APT-COM™ 4 Multi Management Software (accessory, chap. 22.1). The chamber comes equipped with an Ethernet serial interface for computer communication and with a USB interface. In addition, the BINDER APT-COM™ 4 Multi Management Software permits networking up to 100 chambers and connecting them to a PC for controlling and programming, as well as recording and representing temperature data. For further options, see chap. 26.5.

The chambers are equipped with an temperature safety controller acc. to DIN12880:2007. This can be switched in the controller menu between class 2 (temperature limiter for overtemperature) or class 3.3 (temperature safety device for over- and undertemperature protection).

The chambers from size 260 on are equipped with four castors. Both front castors can be easily locked via the attached brakes.

Temperature range at ambient temperature of +22 °C +/- 3°C / 71.6 °F +/- 5.4 °F: 0 °C / 32 °F up to 70 °C / 158 °F.

## 2.1 Chamber overview

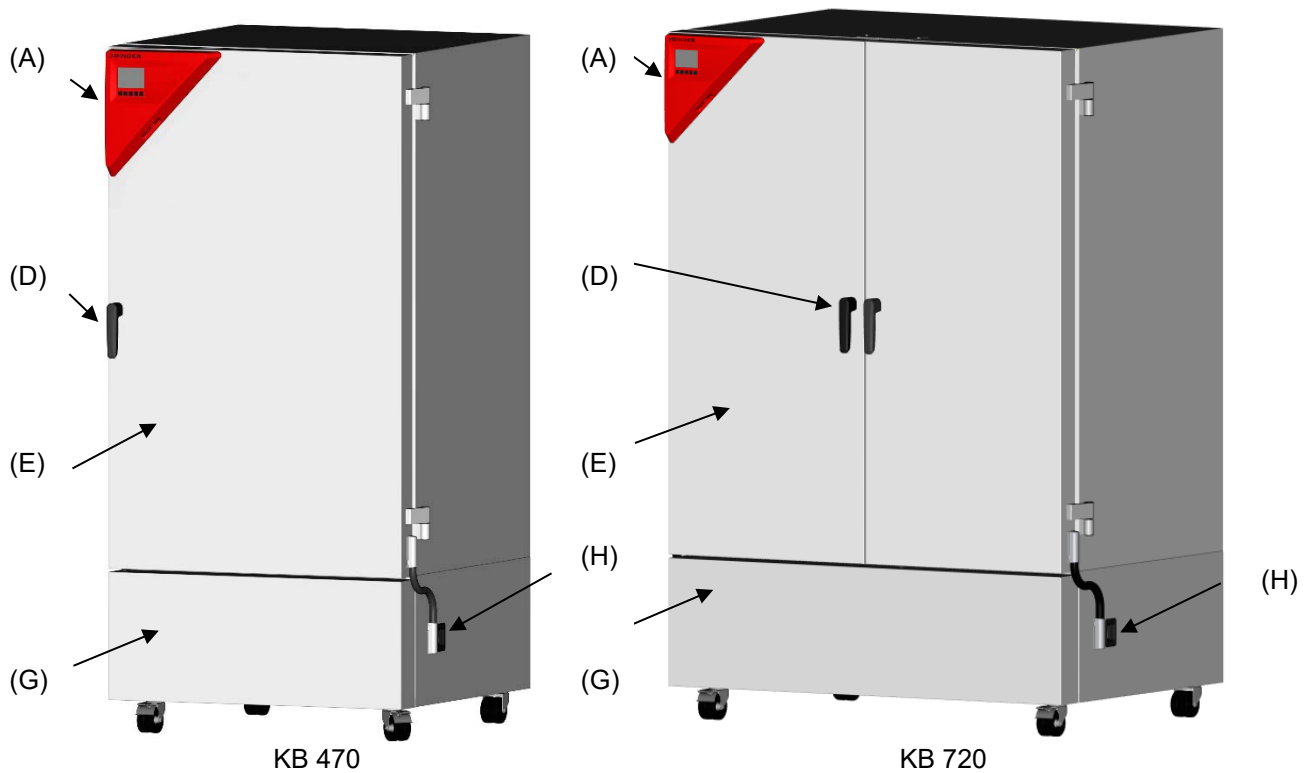
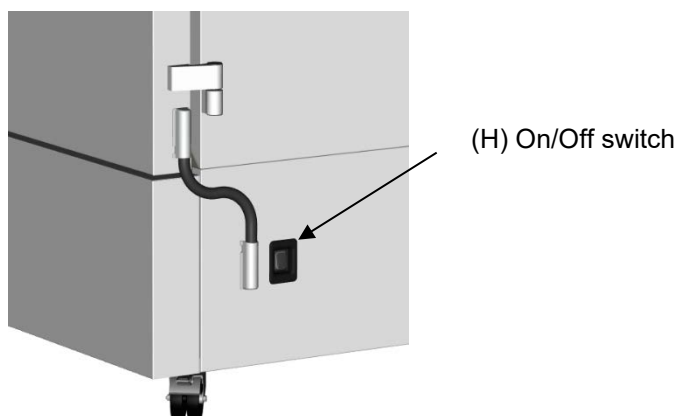

Figure 4: KB / KB-UL cooling incubator

- (A) Triangular instrument panel
- (B), (C) not used
- (D) Door handle
- (E) Outer chamber door(s)
- (F) Inner glass door(s) (not shown)
- (G) Machine room cover (refrigerating machine)
- (H) On/Off switch



## 2.2 Triangular instrument panel

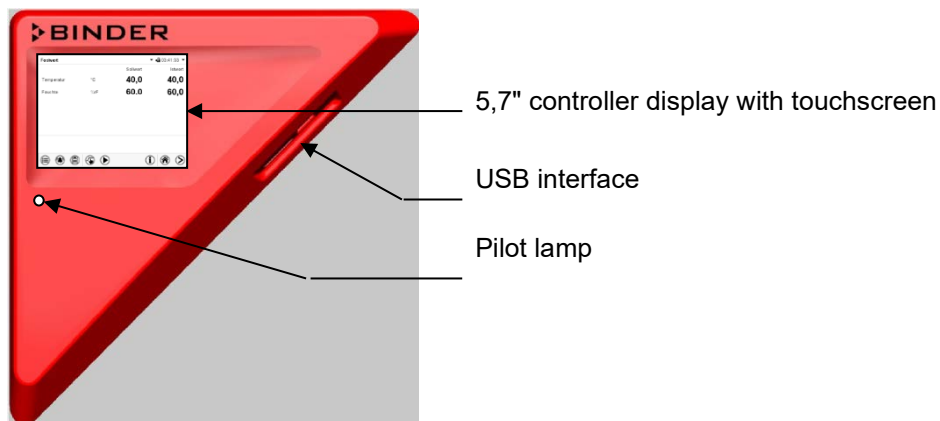

Figure 5: Triangular instrument panel with MB2 program controller and USB interface

## 2.3 Control panel on the chamber rear

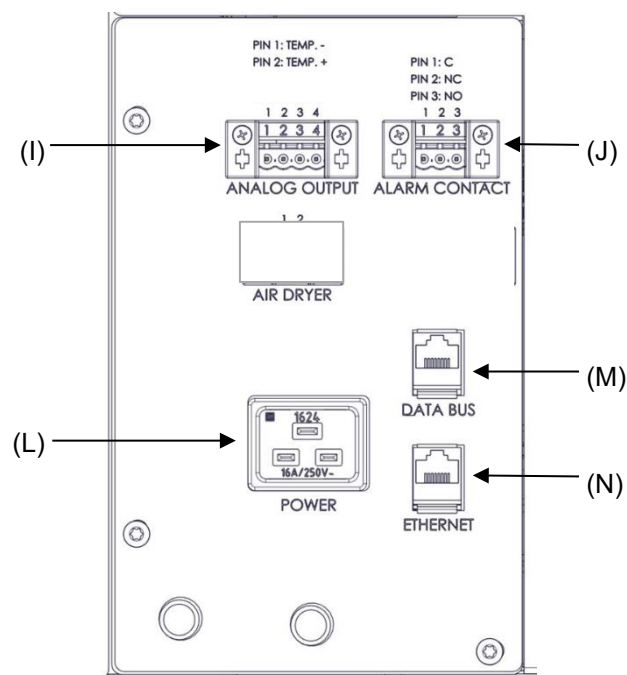

Figure 6: Control panel with connections on the chamber rear, with optional equipment

- (I) Connector for analog outputs (option)
- (J) Connector for zero-voltage relay alarm output (option)
- (K) (not used)
- (L) Power connection
- (M) Data bus
- (N) Ethernet interface





### 3. Completeness of delivery, transportation, storage, and installation

#### 3.1 Unpacking, and checking equipment and completeness of delivery

After unpacking, please check the chamber and its optional accessories, if any, based on the delivery receipt for completeness and for transportation damage. Inform the carrier immediately if transportation damage has occurred.

The final tests of the manufacturer may have caused traces of the shelves on the inner surfaces. This has no impact on the function and performance of the chamber.

Please remove any transportation protection devices and adhesives in/on the chamber and on the doors and remove the operating manuals and accessory equipment.

	<div style="background-color: yellow; text-align: center; padding: 5px;">  <b>CAUTION</b> </div> <p><b>Risk of injury and damages by lifting heavy loads and by sliding or tilting of the chamber due to improper lifting.</b></p> <p><b>Injuries, damage to the chamber.</b></p> <ul style="list-style-type: none"> <li>➤ Do NOT lift or transport the chamber using the door, the handle, or the lower housing.</li> <li>➤ Lift chambers size 65 / 130 from the pallet with the aid of four people in the area of all 4 chamber feet</li> <li>➤ Lift chambers size 260 from the pallet with the aid of six people in the area of all 4 castors or with a fork lifter. Set the fork lifter only from the front or rear in the middle of the chamber.</li> <li>⊘ Do NOT lift chambers sizes 470, 720 and 1060 by hand.</li> <li>➤ Lift the chambers sizes 470, 720, and 1060 from the pallet using technical devices (fork lifter). Set the fork lifter only from the front or rear in the middle of the chamber.</li> <li>➤ Do NOT set the fork lifter from the chamber side.</li> </ul>
--	--

If you need to return the chamber, please use the original packing and observe the guidelines for safe lifting and transportation (chap. 3.2).

For disposal of the transport packing, see chap. 25.1.





#### **Note on second-hand chambers (Ex-Demo-Units):**

Second-hand chambers are chambers that were used for a short time for tests or exhibitions. They are thoroughly tested before resale. BINDER ensures that the chamber is technically sound and will work flawlessly.

Second-hand chambers are marked with a sticker on the chamber door. Please remove the sticker before commissioning the chamber.

### 3.2 Guidelines for safe lifting and transportation

The front castors of the chambers from size 260 on can be blocked by brakes. After operation, please observe the guidelines for temporarily decommissioning the chamber (chap. 25.2). Please move the chambers with castors only when empty and on an even surface, otherwise the castors may be damaged.

   	 <b>CAUTION</b>
<p><b>Risk of injury and damages by lifting heavy loads and by sliding or tilting of the chamber due to improper transportation.</b></p> <p><b>Injuries, damage to the chamber.</b></p> <ul style="list-style-type: none"> <li>➤ Transport the chamber in its original packaging only.</li> <li>➤ For moving or shipping, secure the constant climate chamber with transport straps.</li> <li>➤ Do NOT lift or transport the chamber using the door, the handle, or the lower housing.</li> <li>➤ Lift chambers size 65 / 130 with the aid of four people in the area of all 4 chamber feet</li> <li>➤ Lift chambers size 260 with the aid of six people in the area of all 4 castors or with a fork lifter. Set the fork lifter only from the front or rear in the middle of the chamber.</li> <li>⊘ Do NOT lift chambers sizes 470, 720 and 1060 by hand.</li> <li>➤ Lift the chambers sizes 470, 720, and 1060 using technical devices (fork lifter). Set the fork lifter only from the front or rear in the middle of the chamber.</li> <li>➤ Do NOT set the fork lifter from the chamber side.</li> </ul>	

- Permissible ambient temperature range during transport: -10 °C / 14 °F to +60 °C / 140 °F.

You can order transport packing for moving or shipping purposes from BINDER service.

If the chamber has to be moved sideways through a narrow space, you can open the doors by 180 degrees and remove the cover of the machine room (G) without tools. To do this, lift the cover upwards and pull it forwards. To reattach it, make sure that the retaining eyes at the top and bottom of the cover engage in the retaining screws.

### 3.3 Storage

Intermediate storage of the chamber is possible in a closed and dry room. Observe the guidelines for temporary decommissioning (chap. 25.2).

- Permissible ambient temperature range during storage: -10 °C / 14 °F to +60 °C / 140 °F.
- Permissible ambient humidity: max. 70 % r.h., non-condensing

When after storage in a cold location you transfer the chamber to its warmer installation site, condensation may form. Before start-up, wait at least one hour until the chamber has attained ambient temperature and is completely dry.



In case of a prolonged temporal decommissioning: Leave the chamber door open or remove the access port plugs.

### 3.4 Location of installation and ambient conditions

Set up the constant climate chamber on a flat, even surface, and in a well-ventilated, dry location and align it using a spirit level. The site of installation must be capable of supporting the chamber's weight (see technical data, chap. 26.4). The chambers are designed for setting up inside a building (indoor use).

	NOTICE
	<p><b>Danger of overheating due to lack of ventilation.</b>  <b>Damage to the chamber.</b></p> <ul style="list-style-type: none"> <li>∅ Do NOT install the chamber in unventilated recesses.</li> <li>➤ Ensure sufficient ventilation for dispersal of the heat.</li> <li>➤ Observe the prescribed minimum distances when installing the chamber.</li> </ul>

Do not install or operate the chamber in potentially explosive areas.

	 <b>DANGER</b>
	<p><b>Danger of explosion due to combustible dusts or explosive mixtures in the vicinity of the chamber.</b>  <b>Serious injury or death from burns and / or explosion pressure.</b></p> <ul style="list-style-type: none"> <li>∅ Do NOT operate the chamber in potentially explosive areas.</li> <li>➤ KEEP explosive dust or air-solvent mixtures AWAY from the vicinity of the chamber.</li> </ul>

### Ambient conditions

- Permissible ambient temperature range during operation: +18 °C / 64.4 °F to +32 °C / 89.6 °F. At elevated ambient temperature values, fluctuations in temperature can occur.

	<p>The ambient temperature should not be substantially higher than the indicated ambient temperature of +22 °C +/- 3 °C / 71.6 °F +/- 5.4 °F to which the specified technical data relate. Deviations from the indicated data are possible for other ambient conditions.</p>
--	--

	<p>With each degree of ambient temperature &gt;25 °C / 77 °F, the refrigeration power decreases by 1.5 K.</p>
---	---

- Permissible ambient humidity: 70 % r.h. max., non-condensing

When operating the chamber at temperature set-points below ambient temperature, high ambient humidity may lead to condensation on the chamber.

- Installation height: max. 2000 m / 6562 ft. above sea level.

### Minimum distances

- When placing several chambers of the same size side by side, maintain a minimum distance of 250 mm / 9.84 in between each chamber.
- Wall distances: rear 100 mm / 3.9 in, for sides see information in the Technical Data chap. 26.4.
- Spacing above the chamber of at least 100 mm / 3.9 in must also be accounted for.

### Stacking

Two chambers size 65 / 130 of the same size can be piled on top of each other. For this purpose place rubber pads under every foot of the upper chamber to prevent the device from slipping.

	NOTICE
	<p><b>Danger of damage caused by sliding or tilting of the upper chamber.</b>  <b>Damage to the chambers.</b></p> <ul style="list-style-type: none"> <li>➤ When stacking, place rubber pads under every foot of the upper chamber.</li> <li>➤ Stack only chambers of the same size.</li> </ul>

For safe stacking, the use of an optionally available stacking adapter is recommended.

The chambers sizes 260 / 470 / 720 / 1060 are NOT intended for stacking.

<b>NOTICE</b>	
	<p><b>Danger by stacking.</b> <b>Damage to the chambers.</b></p> <p>∅ Do NOT place the chambers on top of each other.</p>

#### Other requirements

To completely separate the chamber from the power supply, you must disconnect the power plug. Install the chamber in a way that the power plug is easily accessible and can be easily pulled in case of danger.

For the user there is no risk of temporary overvoltages in the sense of EN 61010-1:2010.

With an increased amount of dust in the ambient air, clean the condenser of the refrigeration machine (by suction) several times a year.

Avoid any conductive dust in the ambience according to the chamber layout complying with pollution degree 2 (IEC 61010-1).

## 4. Installation and connections

### 4.1 Spacer for wall distance (from size 260 on)

Please fix both spacers with the supplied screws at the chamber rear. This serves to ensure the prescribed minimum distance to the rear wall of 100 mm / 3.94 in.

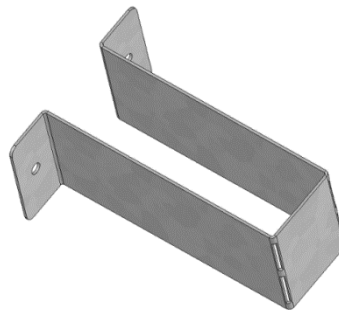

Figure 7: Spacer for wall distance

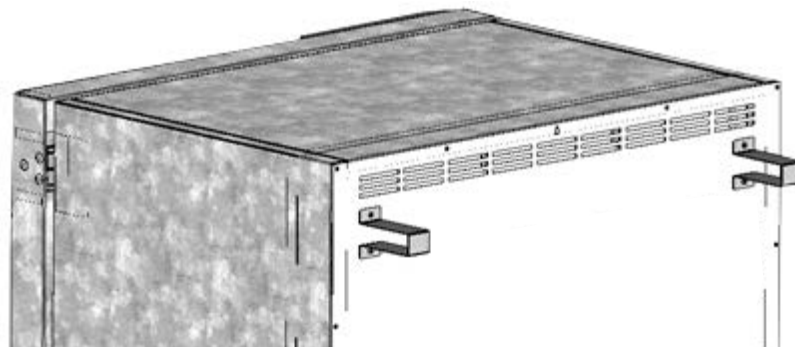



Figure 8: Chamber rear with mounted spacers

## 4.2 Mounting the flexible tilt protection kit (KB/KB-UL 65, 130, 470)

Use the supplied flexible tilt protection kit in addition to the spacers for wall distance (chap. 4.1). This will prevent the chamber from tilting when the door is open.

	<b>NOTICE</b>
	<p><b>Danger of damages caused by tilting of the chamber when the door is open.</b>  <b>Damage to the chamber.</b></p> <p>➤ Fix the chamber to a wall with supplied flexible tilt protection kit</p>

### Scope of delivery:

- 4 Torx screws (spare parts)
- 4 tilt protection holders
- 4 securing straps (2 spare parts)

### Mounting on device side:

- Remove two screws on the upper part of the rear wall (a)
- Fix two of the supplied tilt protection holders, each centrally with one of these screws (b).

### Mounting on wall side

- Fix two of the supplied tilt protection holders in the appropriate distance, each with two screws  $\varnothing$  6mm suitable for the wall (c)

### Connection with the securing straps

- On each side, thread one of the supplied securing straps through the provided slots of a device side and a wall side tilt protection holder

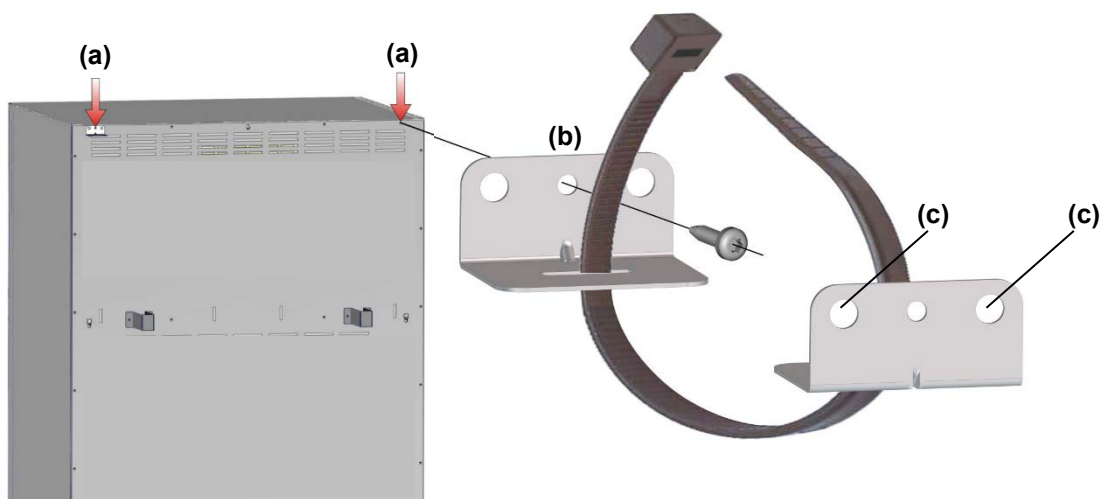

Figure 9: Rear chamber (KB 470) and mounting the flexible tilt protection kit

### 4.3 Condensate collection pan

Emerging condensate is collected in a condensate collection pan which is mounted under the chamber. If necessary, the pan can be removed and emptied at any time.

Under normal operating conditions (e.g. incubation of 100 Petri dishes at 25 ° C) there is so little condensate that it will evaporate in the condensate collection pan so that the collection pan does not have to be emptied. Under operating conditions with increased condensation, the condensate collecting tray should be checked regularly and, if necessary, emptied.

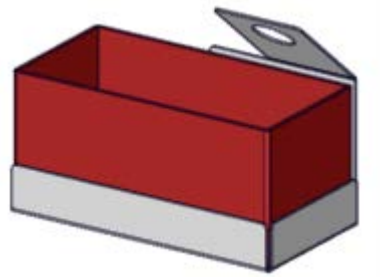

Figure 10: Condensate collection pan

#### Installation of the condensate collection pan

Hang the condensate collection pan on the chamber rear and guide the hose through the latch of the holder.

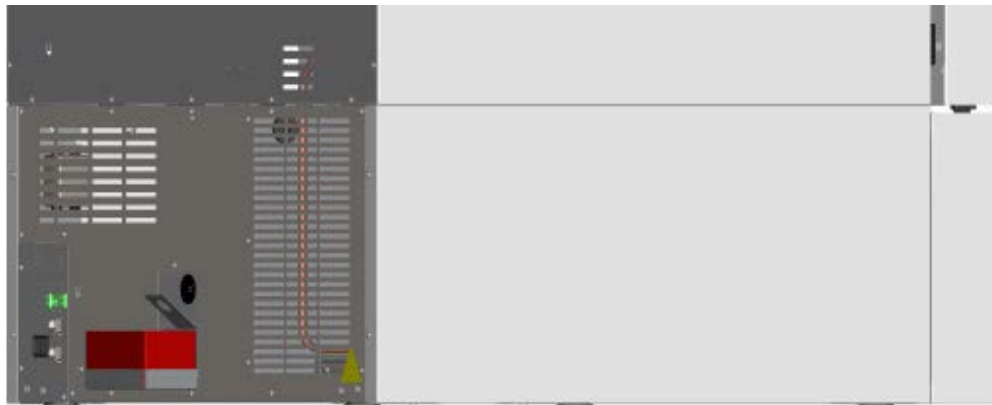

Figure 11: KB 470 with mounted condensate collection pan (detail)

### 4.4 Racks with U-rails or with telescopic rails (accessory)

#### U-rails

The chambers are regularly equipped with U-rails for attaching the racks.



Avoid pulling pull out the racks with U-rails, and if necessary, only when they are unloaded.

The reinforced shelf rack accessory may only be used with U-rails.

#### Telescopic rails

Telescopic rails for attaching the racks are available as accessories. They allow the racks to be pulled out.





Make sure that you only pull out one of the shelf racks at a time and that you maintain the load as specified in the technical data (chap. 26.4).

## 4.5 Electrical connection

The chambers are supplied ready for connection. They come with an IEC connector plug of 2 m / 78.84 in in length.

- Nominal voltage +/-10%:  
KB: 220-240 V at 50 and 60 Hz  
KB-UL: 120 V at 50 and 60 Hz
- Power plug:  
KB: Grounded plug CEE 7/7  
KB-UL: NEMA 5-20P
- Current type: 1N~
- Chamber fuse: 16 A
- The domestic socket must also provide a protective conductor. Make sure that the connection of the protective conductor of the domestic installations to the chamber's protective conductor meets the latest technology. The protective conductors of the socket and plug must be compatible!

	 <b>DANGER</b>
	<p><b>Electrical hazard due to missing protective conductor connection.</b> <b>Deadly electric shock.</b></p> <ul style="list-style-type: none"> <li>➤ Make sure that the chamber's power plug and the power socket match and securely connect the electrical protective conductors of the chamber and the house installation.</li> </ul>

- Only use original connection cables from BINDER according to the above specification.  
KB-UL: Use only a UL Listed Power supply cord (UL category ELBZ), SJT 3x14 AWG (2.08 mm<sup>2</sup>); C13L. For outside USA use a certified power supply cord according to national requirements.
- Prior to connection and start-up, check the power supply voltage. Compare the values to the specified data located on the chamber's type plate (left chamber side, bottom right-hand, see chap. 1.6).

	<b>NOTICE</b>
	<p><b>Danger of incorrect power supply voltage due to improper connection.</b> <b>Damage to the chamber.</b></p> <ul style="list-style-type: none"> <li>➤ Check the power supply voltage before connection and start-up.</li> <li>➤ Compare the power supply voltage with the data indicated on the type plate.</li> </ul>

- When connecting, please observe the regulations specified by the local electricity supply company as well as the local or national electrical regulations (VDE directives for Germany).
- Observe a sufficient current protection according to the number of devices that you want to operate. We recommend the use of a residual current circuit breaker.
- Pollution degree (acc. to IEC 61010-1): 2
- Installation category (acc. to IEC 61010-1): II

See also electrical data (chap. 26.4).

	<p>To completely separate the chamber from the power supply, you must disconnect the power plug. Install the chamber in a way that the power plug is easily accessible and can be easily pulled in case of danger.</p>
---	--

## 5. Functional overview of the RD4 chamber controller

The RD4 chamber controller controls the temperature inside the chamber:

You can enter the desired set point values in the “**Set points**” menu directly at the controller or use the APT-COM™ 4 Multi Management Software (accessory) specially developed by BINDER.

The controller offers various notifications and alarm messages with visual and audible indication. All controller settings remain valid until the next manual change. They are stored also after turning off the chamber.

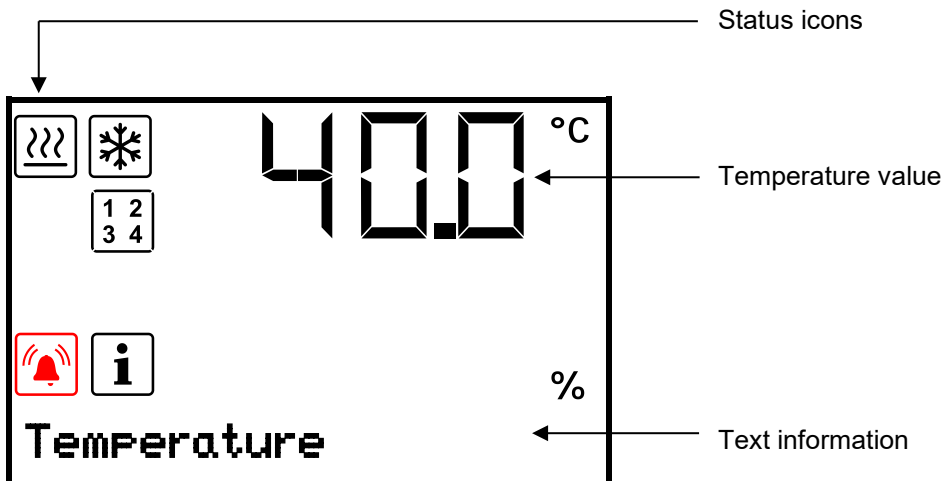











Figure 12: Normal display of the RD4 controller (sample values)

### Status icons in the controller display

Icon	Signification	Icon	Signification
	Heating active		Display of activated special controller functions. 1 = Idle mode, 2 = Object temperature control, 3 = Door lock, 4 = Internal light
	Refrigeration active		Collective alarm
	Information		

### Functional controller keys

Icon	Signification	Function
	<b>Arrow-up button</b>	<ul style="list-style-type: none"> <li>Navigate between menus, submenus, other functions</li> <li>In the setting menu: change setting, increase value</li> </ul>
	<b>Arrow-down button</b>	<ul style="list-style-type: none"> <li>Navigate between menus, submenus, other functions</li> <li>In the setting menu: change setting, decrease value</li> </ul>
	<b>OK button</b>	<ul style="list-style-type: none"> <li>Select menu, submenu, function</li> <li>In the setting menu: Confirm entry</li> </ul>
	<b>Back button</b>	Back to previous menu level
	<b>Standby button</b>	no function



## 5.1 Menu structure of the controller and access levels

Starting from **Normal display**, navigate between the menus with the **arrow buttons**.

With the **OK button** you enter the setting of further subordinate menu functions.

With the **Back button** you go back to the previous function and finally back to Normal display.

The available functions depend on the current dependent on the current **authorization** "User", "Admin" or "Service", for which the entry of a password may be required, depending on the setting.

You can set passwords for different access levels:

- **User:** The password enables access to the standard operating functions. Factory setting is 00 00 (no password assigned).
- **Admin:** The password enables access to advanced controller functions and settings. Factory setting is 00 01.
- **Service:** The password enables access to all controller functions (for BINDER Service only).

As soon as a password has been assigned, access to the respective functions is blocked and only available after entering the correct password.

Menu	Required access level	Functions
<b>Disinfection</b>	"User"	<ul style="list-style-type: none"> <li>• Activating/deactivating hot-air disinfection</li> </ul>
<b>Setpoints</b>	"User"	<ul style="list-style-type: none"> <li>• Temperature set-point setting</li> <li>• Fan speed set-point setting</li> <li>• Setting the safety controller</li> <li>• Activating/deactivating operating mode "Idle mode"</li> <li>• Activating/deactivating the object temperature control</li> <li>• Activating/deactivating the door lock</li> <li>• Activating/deactivating the continuous internal light</li> </ul>
<b>Setpoint switchover</b>	"User"	<ul style="list-style-type: none"> <li>• Automatic setpoint switchover</li> </ul>
<b>Chamber info</b>	Any user	<ul style="list-style-type: none"> <li>• Configuration display (setup information, controller hardware and software, analog inputs)</li> <li>• Display of interface configuration (e.g. MAC address, IP address)</li> </ul>
<b>Settings</b>	"Admin"	<ul style="list-style-type: none"> <li>• General controller settings (date, time, menu language, temperature unit, display brightness...)</li> <li>• Network settings</li> <li>• Setting the data logger storage interval</li> <li>• Setting the tolerance range limits and delay time for tolerance range alarm</li> <li>• Selecting the safety controller class 2 or 3.3</li> <li>• Setting the lower temperature limit</li> <li>• Activating/deactivating anti-condensation protection</li> <li>• Selecting the sensitivity of the object temperature control (option)</li> <li>• Self-test function</li> <li>• Password changing for User and Admin</li> </ul>

Menu	Required access level	Functions
<b>Service</b>	“Service”	<ul style="list-style-type: none"> <li>• Configuration settings (only for BINDER Service)</li> <li>• Password changing for User and Admin</li> </ul>
<b>USB</b> (visible when inserting a USB stick)	Export: Any user Import: “Admin”	<ul style="list-style-type: none"> <li>• Export of configuration, logger, and service data</li> <li>• Import of configuration data</li> </ul>

Unless noted otherwise, the figure in this manual show the functional range, which is available for the user with “Admin” authorization level

Note: When specifying the path to the respective function, the possibly required entry of a password is not listed

## 5.2 Performance during and after power failures

During a power failure, all controller functions are shut down.

After the power returns, all functions return to the same status the chamber had before power failure. The set-points are immediately resumed.

If during power failure an alarm has occurred (tolerance range, safety controller etc.), confirm the alarm. See chap. 15.

## 6. Start up

After connecting the power supply, turn on the chamber by the On/Off switch (H). The lit pilot lamp shows the chamber is ready for operation.

The controller shows normal display and controls temperature to the last entered values.

Warming chambers may release odors in the first few days after commissioning. This is not a quality defect. To reduce odors quickly we recommend running the hot-air disinfection program once or twice in a well-ventilated location.



**WARNING:** If customer should use a BINDER chamber running in non-supervised continuous operation, we strongly recommend in case of inclusion of irrecoverable specimen or samples to split such specimen or samples and store them in at least two chambers, if this is feasible.

If the function “Language selection at restart” has been activated (chap. 13.5, factory setting ON), the following settings are checked upon start up:

- **Menu language** (chap. 13.1):  
Use the **arrow buttons** to select the desired language, confirm with the **OK button**
- **Temperature unit** (chap. 13.2):  
Use the **arrow buttons** to select the desired temperature unit, confirm with the **OK button**.
- **Current date** (chap. 13.3), format DD MM YYYY:  
Use the **arrow buttons** to set the day, continue with the **OK button**.  
Use the **arrow buttons** to set the month, continue with the **OK button**.  
Use the **arrow buttons** to set the year, confirm with the **OK button**
- **Current time** (chap. 13.4), format HH:MM:  
Use the **arrow buttons** to set the hours, continue with the **OK button**.  
Use the **arrow buttons** to set the minutes, confirm with the **OK button**

## 7. Set-point entry

Required access level: "User".

	Setting ranges	Control ranges
Temperature	-5 °C / 23 °F up to 70 °C / 158 °F	0 °C / 32 °F up to 70 °C / 158 °F
Fan speed	40 % up to 100 %	

### 7.1 Temperature set-point entry

Path: **Normal display**   **Setpoints**  **Temperature**

Press the **OK button** to enable the setting.

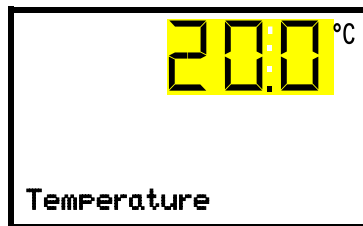

Temperature setting.

The current setting flashes. Enter the desired set-point with the **arrow buttons**.

Confirm the entry with the **OK button**.

With the **arrow-down button** you can continue with the fan speed set-point entry (chap. 7.2).

With the **Back button** you can go back to the "Setpoints" submenu and, repeatedly pressing it, to **Normal display**.



With safety controller mode "**Limit**", adapt the safety controller always when you changed the temperature set-point. Set the safety controller value by approx. 2 °C to 5 °C above the temperature set-point (chap. 12.2).

Recommended setting: Safety controller mode "**Limit**" set to the maximum permissible temperature that must not be exceeded in the interior.

With safety controller mode "**Offset**" the safety controller is triggered if the temperature drops below the set-point.

### 7.2 Fan speed set-point entry

Required access level: "User".

Path: **Normal display**   **Setpoints**   **Fan speed**

Press the **OK button** to enable the setting.

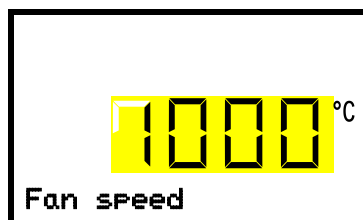

Fan speed setting.

The current setting flashes. Enter the desired set-point with the **arrow buttons**.

Confirm the entry with the **OK button**.

With the **arrow-up button** you can go back to the temperature set-point entry (chap. 7.1).

With the **arrow-down button** you can now change to the special controller functions setting (chap. 8).

With the **Back button** you can go back to the "Setpoints" submenu and, repeatedly pressing it, to **Normal display**.

## 8. Setting special controller functions

Required access level: "User".

Path: **Normal display**   **Setpoints**    **Functions on/off**

You can define the switching state of up to four controller functions.

- Function 1 "Idle mode" is used to switch on/off operating mode "Idle mode", i.e. to deactivate all chamber functions except the controller. With operating mode "Idle mode", the heating, refrigerating, and fan are deactivated.
- Function 2 "Object temp. Control" is used to switch on/off the object temperature control 1
- Function 3 "Door lock" is used to switch on/off the door lock
- Function 4 "Internal light" is used to activate/deactivate the continuous internal light

The functions are displayed from left to right.

**Example:** Function 1 activated = 0001. Function 1 deactivated = 0000.

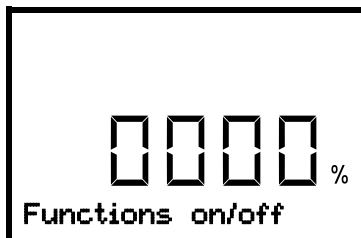

Submenu "Functions on/off".

This view shows the switching states of the four controller functions.

"1" = Function activated

"0" = Function deactivated

Press the **OK button** to access the first individual function. With the **arrow-down button** you can proceed to the subsequent functions and access it with the **OK button**.

Then press the **OK button** to enable the setting of the desired function and select the function's switching state "1" (function activated) or "0" (function deactivated).

**Example:** Function 1 "Idle mode"

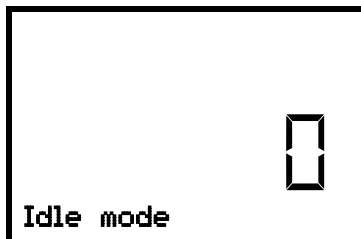

Function 1 "Idle mode".

The current switching state is shown (example).

Press the **OK button** to enable the setting.

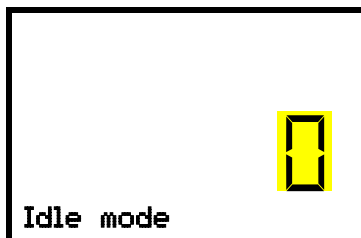

Setting function 1 "Idle mode".

The current setting flashes. Use the **arrow buttons** to select between 0 (deactivated function) and 1 (activated function).

Confirm the setting with the **OK button**.

Press the **arrow-down button** to access the next function. Press the **OK button** to enable the setting of the desired function and select the function's switching state "1" (function activated) or "0" (function deactivated).

With the **Back button** you can go back to the **"Functions on/off"** submenu and, repeatedly pressing it, to **Normal display**.

In Normal display the activated functions are indicated by an icon showing the number of the respective function. The "Info" icon flashes slowly. While it is lit, the lower text informs about the activated functions.

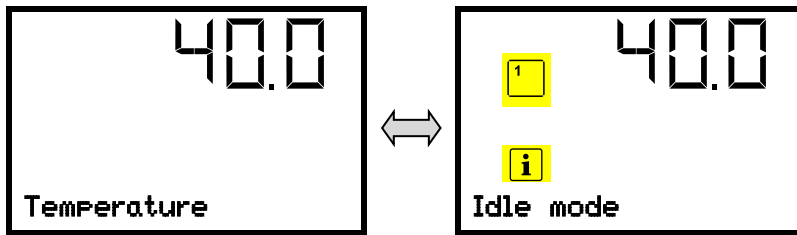

Example:  
Normal display with activated function 1 "Idle mode".

If several functions are active at the same time, the icon shows the combination of the corresponding numbers, e.g. .

## 9. Automatic setpoint switchover

Required access level: "User".

### Control modes

With the setpoint switchover, an automatic switchover of the setpoint, e.g. at weekends or on a specific date, can be programmed. To do this, an alternative setpoint is entered in this menu. By entering a weekday and / or date and time, the setpoint changeover works reliably even in the event of an intermittent power failure.

- **Cyclic control:** The alternative setpoint is regularly activated and deactivated on a specific weekday / time. This control mode is suitable e.g. for weekends.
- **Control by date:** The alternative setpoint is activated and deactivated once on an entered date / time. This control mode is suitable for special dates, e.g. holidays.

### Indication

As soon as the automatic setpoint switchover (control by date or cyclic control) has been activated, the information text "Setpoint switchover active" is shown alternating with "Temperature" in Normal Display" as soon as the alternative setpoint is switched.

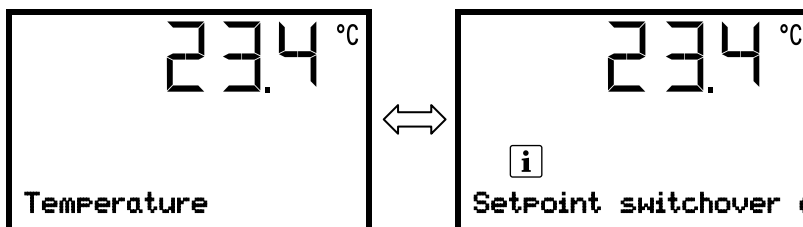

Normal Display with active alternative setpoint, currently switched to the alternative setpoint (sample values)

### Safety controller

The safety controller settings remain in effect. Please note that with the set-point type offset, the automatic switchover can trigger a safety controller alarm. Recommended setting: Setpoint type "Limit" above the higher of the two set-points.

The tolerance band alarm is always effective.

### Setting

Path: **Normal display**   **Setpoint switchover**

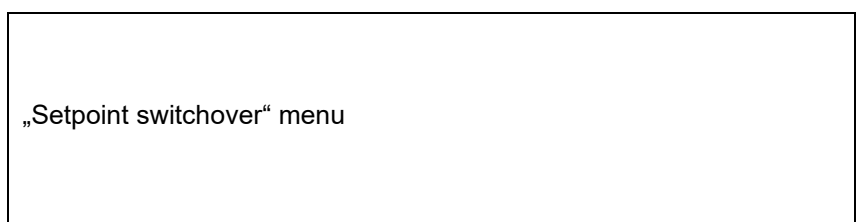

With the **OK button** you can change to activate/deactivate and configure the Control by date.

With the **OK button** + **arrow-down button** you can change to activate/deactivate and configure the der Cyclic control.

In state of delivery, both control modes are deactivated.

As soon as one of the control is activated, setpoint switchover becomes enabled.

## 9.1 Control by date

In this menu you can enter date and time at which the alternative setpoint should be activated and deactivated once.

Path: **Normal display**    **Setpoint switchover**  **Date controlled**

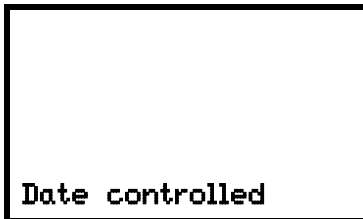

"Date controlled" menu

Press the **OK button** to enable the setting.

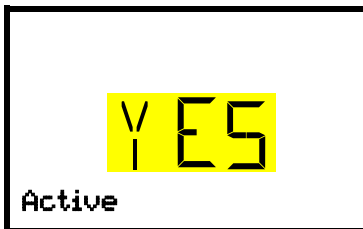

"Active" submenu  
The current setting flashes. Select with the **arrow buttons** between YES (date controlled switchover active) and NO (no date controlled switchover).  
To activate date controlled switchover, select "YES" and press the **OK button** to confirm.

With the **arrow-down button** you can change to enter the **date to activate the alternative setpoint**. Press the **OK button** to enable the setting.



Setting the date: day  
The current setting flashes. Enter the desired day with the **arrow buttons**.  
Confirm the entry with the **OK button**.



Setting the date: month  
The current setting flashes. Enter the desired month with the **arrow buttons**.  
Confirm the entry with the **OK button**.



Setting the date: year  
The left two digits are flashing. Enter the first two digits of the desired year with the **arrow buttons**.  
Confirm the entry with the **OK button**.

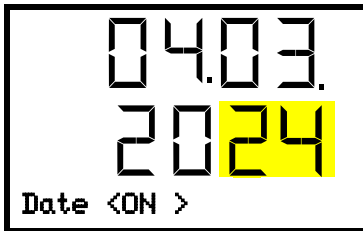

Setting the date: year  
 The right two digits are flashing. Enter the last two digits of the desired year with the **arrow buttons**.  
 Confirm the entry with the **OK button**.

With the **arrow-down button** you can change to enter the **time to activate the alternative setpoint**. Press the **OK button** to enable the setting.

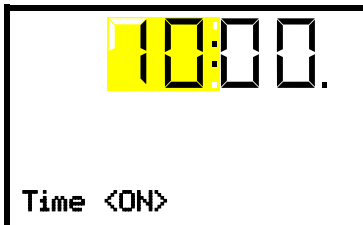

Setting the time: hours  
 The current setting flashes. Enter the desired hour with the **arrow buttons**.  
 Confirm the entry with the **OK button**.

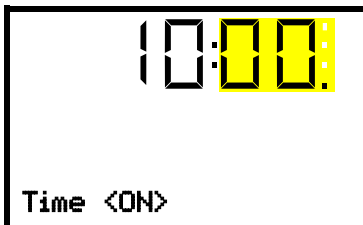

Setting the time: minutes  
 The current setting flashes. Enter the desired minutes with the **arrow buttons**.  
 Confirm the entry with the **OK button**.

With the **arrow-down button** you can change to enter the **date to deactivate the alternative setpoint**. Press the **OK button** to enable the setting

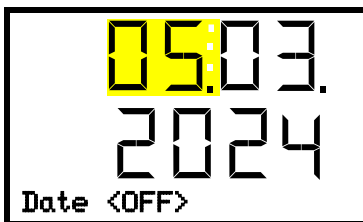

Setting the date: day  
 The current setting flashes. Enter the desired day, month, and year with the **arrow buttons** and confirm all entries each entry with the **OK button**.

With the **arrow-down button** you can change to enter the **time to deactivate the alternative setpoint**. Press the **OK button** to enable the setting



Setting the time: hours  
 The current setting flashes. Enter the desired hour and minutes with the **arrow buttons** and confirm all entries each entry with the **OK button**.

With the **Back button** you can go back to the “**Setpoint switchover**” submenu and, repeatedly pressing it, to **Normal display**.

## 9.2 Regular cyclic control

In this menu you can enter the day of the week and the time at which the alternative setpoint should be regularly activated and deactivated.

Path: **Normal display**    **Setpoint switchover**   **Cyclic**

Press the **OK button** to enable the setting.

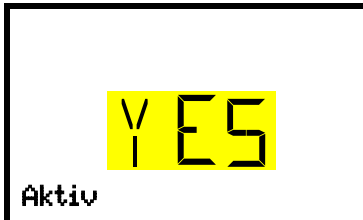

“Active” submenu

The current setting flashes. Select with the **arrow buttons** between YES (cyclic control active) and NO (no cyclic control).

To activate cyclic control, select “YES” and press the **OK button** to confirm.

With the **arrow-down button** you can change to enter the **day of the week to activate the alternative setpoint**. Press the **OK button** to enable the setting



Setting the weekday: “Weekday <ON>” submenu

The current setting flashes. Use the **arrow buttons** to select the desired day of the week to activate the alternative setpoint

Sun / Mon / Tue / Wed / Thu / Fri / Sat  
and confirm the entry with the **OK button**.

With the **arrow-down button** you can change to enter the **time to activate the alternative setpoint**. Press the **OK button** to enable the setting

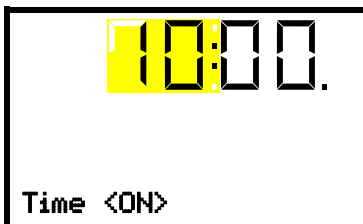

Setting the time: hours

The current setting flashes. Enter the desired hour with the **arrow buttons**.

Confirm the entry with the **OK button**.

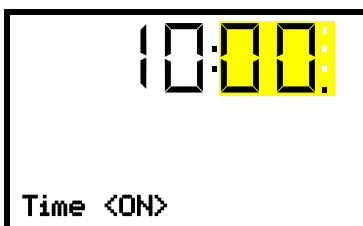

Setting the time: minutes

The current setting flashes. Enter the desired minutes with the **arrow buttons**.

Confirm the entry with the **OK button**.

With the **arrow-down button** you can change to enter the day of the week to deactivate the alternative setpoint. Press the **OK button** to enable the setting



Setting the weekday: “Weekday <OFF>” submenu

The current setting flashes. Use the **arrow buttons** to select the desired day of the week to deactivate the alternative setpoint

Sun / Mon / Tue / Wed / Thu / Fri / Sat  
and confirm the entry with the **OK button**.

With the **arrow-down button** you can change to enter the **time to deactivate the alternative setpoint**. Press the **OK button** to enable the setting.



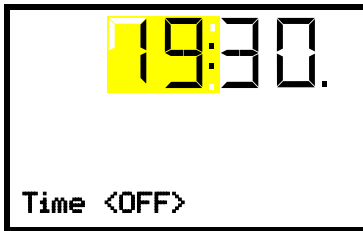

Setting the time: hours

The current setting flashes. Enter the desired hour and minutes with the **arrow buttons** and confirm all entries each entry with the **OK button**.

With the **Back button** you can go back to the “**Setpoint switchover**” submenu and, repeatedly pressing it, to **Normal display**.

### 9.3 Entry of the alternative temperature set-point

The alternative temperature setpoint is activated or deactivated again at the switching times set via the control by date and / or the cyclic control.

Path: **Normal display**    **Setpoint switchover**    **Temperature**

Press the **OK button** to enable the setting.



Temperature setting.

The current setting flashes. Enter the desired set-point with the **arrow buttons**.

Confirm the entry with the **OK button**.

With the **Back button** you can go back to the “**Setpoint switchover**” submenu and, repeatedly pressing it, to **Normal display**.

### 9.4 Activating / deactivating special controller functions

You can also activate the special controller functions for the switching times set via the control by date and / or the cyclic control.

Path: **Normal display**    **Setpoint switchover**     **Functions on/off**

You can define the switching state of the four controller functions.

- Function 1 “Idle mode” is used to switch on/off operating mode “Idle mode”, i.e. to deactivate all chamber functions except the controller. With operating mode “Idle mode”, the heating, refrigerating, and fan are deactivated.
- Function 2 : “Object temp. Control” is used to switch on/off the object temperature control 1
- Function 3 : “Door lock” is used to switch on/off the door lock
- Function 3 : “Internal light” is used to activate/deactivate the continuous internal light

The functions are displayed from left to right.

**Example:** Function 1 “Idle mode” activated = 0001. Function 1 “Idle mode” deactivated = 0000.

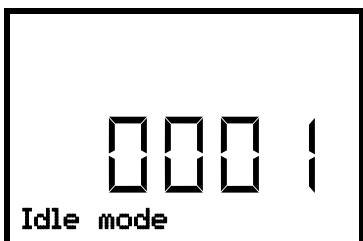

Submenu “**Functions on/off**”.

This view shows the switching states of the four available functions.

“1” = Activated function

“0” = Deactivated function

Press the **OK button** to access the first individual function. With the **arrow-down button** you can proceed to the subsequent functions and access it with the **OK button**.

Then press the **OK button** to enable the setting of the desired function and select the function's switching state "1" (function activated) or "0" (function deactivated).

**Example:** Function 1 "Idle mode"

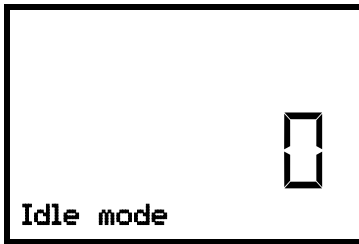

Function 1 "Idle mode".  
The current switching state is shown (example).

Press the **OK button** to enable the setting.

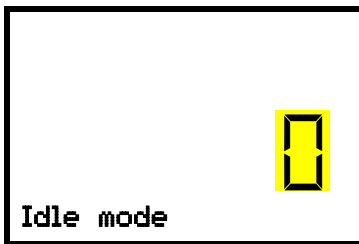

Setting function 1 "Idle mode".  
The current setting flashes. Use the **arrow buttons** to select between 0 (deactivated function) and 1 (activated function).  
Confirm the setting with the **OK button**.

With the **Back button** you can go back to the "**Setpoint switchover**" submenu and, repeatedly pressing it, to **Normal display**.

In Normal display, when switched to the alternative setpoint, the activated functions are indicated by an icon showing the number of the respective function. The "Info" icon flashes slowly. While it is lit, the lower text informs about the activated functions.

## 10. Hot-air disinfection

The chamber has an automatic hot-air disinfection function. This means that the chamber is disinfected during a program holding time of 12 hours at 100 °C / 212 °F.

### 10.1 Preparations

- Remove all samples, installations or other items that could be damaged or destroyed by 100 °C / 212 °F from the interior of the chamber
- Clean the chamber
- Close the inner glass door(s) and the outer chamber door(s)
- Turn on the chamber

### 10.2 Starting the hot-air disinfection

Required access level: "User".

Path: **Normal display**  **Disinfection**



"Disinfection" menu.  
In this menu you can start the hot-air disinfection or stop a running hot-air disinfection.

With the **Back button** you can go back to **Normal display**.

Press the **OK button** to enter the disinfection submenu.

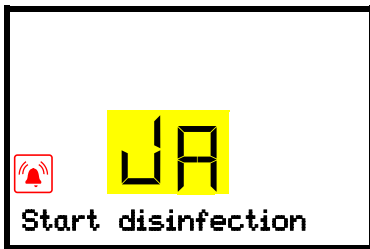

“Start disinfection” submenu

The current setting flashes. Select with the **arrow buttons** between YES (start disinfection) and NO (do not start disinfection).

To start the hot-air disinfection, select “YES” and press the **OK button** to confirm.

After selecting “NO”: The controller changes back to the “Disinfection” menu.

After selecting “YES”: Hot-air disinfection starts and the controller changes to Normal display.

### 10.3 Hot air disinfection process

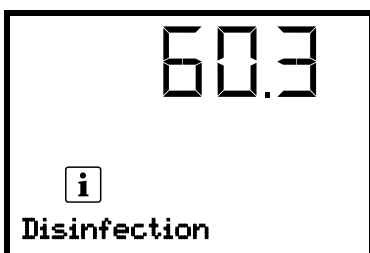



Normal display during hot-air disinfection

The information message “Disinfection” is shown alternating with the indication “Temperature”.



The safety controller settings are inactive during hot-air disinfection. They become functional again following termination of the hot-air disinfection and/or restarting the chamber at the On/Off switch (H).

The glass door and inner chamber become hot during hot-air disinfection.

	 <b>CAUTION</b>
	<p><b>Danger of burning by touching hot chamber parts during hot-air disinfection. Burns.</b></p> <p>⊘ Do NOT touch the glass door, glass door, inner surfaces, and door gaskets during hot-air disinfection.</p>

### 10.4 Completing the hot-air disinfection

The effective hot-air disinfection is finished after a 12 hours holding phase.

As soon as the chamber has cooled down to the set-point value +1K entered in fixed value mode, the information message “Disinfection successful” indicates the successful hot-air disinfection.



Normal display after completed hot-air disinfection.

The information message “Disinfection successful” is shown alternating with the indication “Temperature”.

## 10.5 Prematurely terminating the hot-air disinfection

The hot-air disinfection can be cancelled prematurely via the controller menu.

- After premature termination the chamber reverts to its standard operational status.

Under no circumstances open the doors of the chamber until the interior temperature has dropped.

As long as the interior temperature is still above the limit threshold of the temperature alarm, the chamber will generate corresponding alarm messages, which you can ignore. You can reset the acoustic alarm of the safety controller by pressing the **OK button**.

If necessary, repeat the hot-air disinfection.

### Cancelling the hot-air disinfection via the controller menu

Required access level: "User".

Path: **Normal display**  **Disinfection**



"Disinfection" menu.

In this menu you can start the hot-air disinfection or stop a running hot-air disinfection.

With the **Back button** you can go back to **Normal display**.

Press the **OK button** to enter the disinfection submenu.

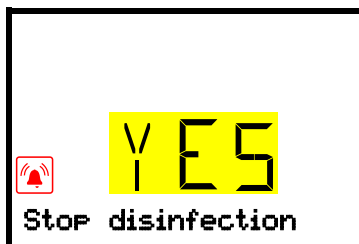

"Stop disinfection" submenu.

The current setting flashes. Select with the **arrow buttons** between YES (stop disinfection) and NO (do not stop disinfection).

To stop the hot-air disinfection, select "YES" and press the **OK button** to confirm.

After selecting "NO": The controller changes back to the "Disinfection" menu.

After selecting "YES": The controller changes to Normal display. The hot-air disinfection is terminated.

## 11. Password

### 11.1 Password request

To access menus for which access is restricted, you must enter the corresponding password.

After calling the appropriate menu function with the **OK button** the password request appears.

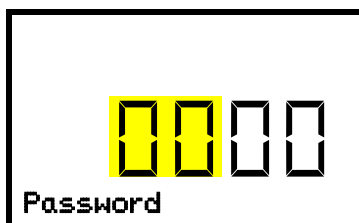

Password request.

The left two digits are flashing. Enter the desired numbers with the **arrow buttons**.

Confirm the setting with the **OK button**.

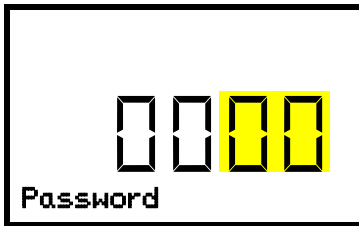

Password request.  
The right two digits are flashing. Enter the desired numbers with the **arrow buttons**.  
Confirm the setting with the **OK button**.

Upon entering an incorrect password, the message "Wrong password" is displayed.

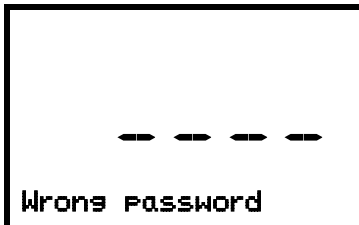

Display "Wrong password".  
After 3 seconds the controller changes again to the password entry.  
Enter the correct password.

Following correct password entry, you can access the desired menu function.

## 11.2 Assign and modify a password

In this menu you can assign and modify the passwords of the "User" and "Admin" access levels.

Required access level: "Admin".



Keep the password well in mind. There is no access to the corresponding menu functions without the correct password.

### 11.2.1 Assign and modify the User password

Path: **Normal display** ▾ ▾ ▾ ▾ ▾ **Settings**  **Chamber** ▾ ▾ ▾ ▾ **Password User**

Press the **OK button** to enable the setting.

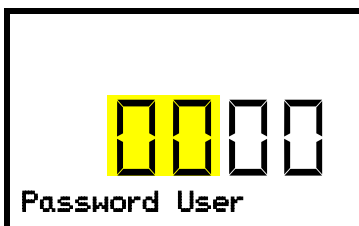

Setting the User password.  
The left two digits are flashing. Enter the desired numbers with the **arrow buttons**.  
Confirm the setting with the **OK button**.

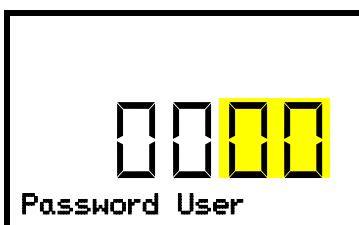

Setting the User password.  
The right two digits are flashing. Enter the desired numbers with the **arrow buttons**.  
Confirm the setting with the **OK button**.

With the **arrow-down button** you can now proceed to enter the Admin password.

With the **Back button** you can go back to the "Chamber" submenu and, repeatedly pressing it, to **Normal display**.

## 11.2.2 Assign and modify the Admin password

Path: **Normal display** ▾ ▾ ▾ ▾ ▾ **Settings**  **Chamber** ▾ ▾ ▾ ▾ ▾ **Password Admin**

Press the **OK button** to enable the setting.

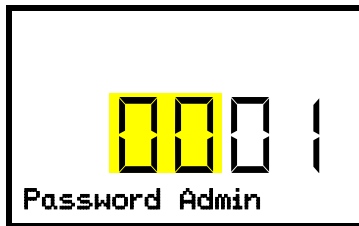

Setting the Admin password.

The left two digits are flashing. Enter the desired numbers with the **arrow buttons**.

Confirm the setting with the **OK button**.

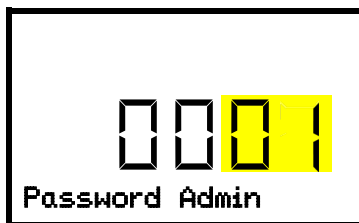

Setting the Admin password.

The right two digits are flashing. Enter the desired numbers with the **arrow buttons**.

Confirm the setting with the **OK button**.

With the **Back button** you can go back to the "**Chamber**" submenu and, repeatedly pressing it, to **Normal display**.

## 12. Temperature safety devices

### 12.1 Over temperature protective device (class 1)

The chamber is equipped with an internal temperature safety device, class 1 acc. to DIN 12880:2007. It serves to protect the chamber and prevents dangerous conditions caused by major defects.

If a temperature of approx. 120 °C / 248 °F is reached, the over temperature protective device permanently turns off the chamber. The user cannot restart the device again. The protective cut-off device is located internally. Only a service specialist can replace it. Therefore, please contact an authorized service provider or BINDER Service.

### 12.2 Safety controller class 2 / class 3.3

The chambers are regularly equipped with an adjustable electronic safety controller. It serves to protect the chamber, its environment and the contents against exceeding the maximum permissible temperature. Please observe the regulations applicable to your country (for Germany: DGUV guidelines 213-850 on safe working in laboratories, issued by the employers' liability insurance association).

In the controller menu you can select between a safety controller class 2 (overtemperature limiter, not self-resetting) or class 3.3 (under- and overtemperature protection, self-resetting) acc. to DIN 12880:2007:



If the safety controller is set to class 2, controller settings made for undertemperature protection are not effective.

- **Overtemperature safety controller class 2 (overtemperature limiter)**

The overtemperature safety controller class 2 is not self-resetting, i.e., it must be acknowledged with the **OK button** before the heaters are switched on again.

The safety controller class 2 limits the temperature inside the chamber to the entered safety controller set-point. In the event of a fault (if this maximum temperature is exceeded) the safety controller completely turns off the heaters until manual reset.

This condition (state of alarm) is indicated visually and additionally with an audible alert if the buzzer is enabled (chap. 15.3).

You can turn off the buzzer with the **OK button**. The alarm persists until the chamber cools down below the configured safety controller value. The heaters are only switched on again if the class 2 safety controller has been acknowledged with the **OK button**.

If the safety controller class 2 has turned off the heaters, we recommend proceeding as follows:

- Disconnect the chamber from the power supply.
- Have an expert examine and rectify the cause of the fault.
- Restart the chamber
- Reset the alarm message

- **Overtemperature safety controller class 3.1 (overtemperature protection)**

The class 3.1 safety controller ensures that a maximum temperature value is not exceeded. If the current temperature is above the selected safety controller setpoint, the safety controller switches off the heaters. It is self-resetting, i.e., it switches the heaters on again automatically when the temperature falls below the selected safety controller set-point. This protection against excessive temperatures serves, for example, to protect the loading material against excessively high temperatures.

The safety controller class 3.1 limits the temperature inside the chamber to the entered safety controller set-point. In the event of a fault (if this maximum temperature is exceeded), it takes over the control to this value. This condition (state of alarm) is indicated visually and additionally with an audible alert if the buzzer is enabled (chap. 15.3).

The safety controller keeps control of the chamber until the chamber temperature cools down below this value. When the chamber has cooled down below the configured safety controller value, the heaters are activated again. You can then reset the alarm on the controller.

If the safety controller class 3.1 has taken over control, we recommend proceeding as follows:

- Disconnect the chamber from the power supply.
- Have an expert examine and rectify the cause of the fault.
- Restart the chamber
- Reset the alarm message

- **Undertemperature safety controller class 3.2 (undertemperature protection)**

The class 3.2 safety controller ensures that a minimum temperature value is not fallen below. If the current temperature is below the selected trigger value, the safety controller switches off the refrigerating system. It is self-resetting, i.e., it switches the refrigerating system on again automatically when the temperature rises above this value. This protection against excessively low temperatures serves, for example, to protect the loading material against cooling down.

The safety controller class 3.2 limits the temperature inside the chamber to the entered trigger value. In the event of a fault (if this minimum temperature is fallen below), it takes over the control to this value. This condition (state of alarm) is indicated visually and additionally with an audible alert if the buzzer is enabled (chap. 15.3).

The safety controller keeps control of the chamber until the chamber temperature rises above this value. When the chamber has risen above the configured safety controller value, the refrigerating system are activated again. You can then reset the alarm on the controller.

If the safety controller class 3.2 has taken over control, we recommend proceeding as follows:

- Disconnect the chamber from the power supply.
- Have an expert examine and rectify the cause of the fault.
- Restart the chamber
- Reset the alarm message



The combination of both safety controllers (overtemperature protection class 3.1 and undertemperature protection class 3.2) is considered as a temperature protection **class 3.3**.

## 12.2.1 Selecting between safety controller class 2 (temperature limiter) or class 3.3 (temperature protection)

You have the option of operating the safety controller with class 2 or 3.3 functionality.

Required access level: "Admin".

Path: **Normal display** ▾ ▾ ▾ ▾ ▾ **Settings**  ▾ ▾ ▾ **Various**  ▾ ▾ **Safety controller class**

Press the **OK button** to enable the setting.

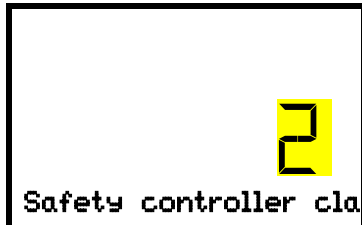

Selecting the class of the safety controller.

The current setting flashes. Use the **arrow buttons** to enter the desired class: "2" or "3". Factory setting: class 3.

Confirm the entry with the **OK button**.

With the **Back button** you can go back to the "**Various**" submenu and, repeatedly pressing it, to **Normal display**.

The functionality of the safety controller and the corresponding setting menus in the controller are adapted to the selection made here.



If the safety controller is set to class 2, controller settings made for undertemperature protection are not effective.

## 12.2.2 Safety controller mode

You can set the **safety controller mode** to "Limit" or "Offset".

- **Limit: Effective for class 2 / 3.1 overtemperature protection**

Limit value, absolute maximum permitted temperature value

This setting offers high safety as a defined temperature limit will not be exceeded. It is important to adapt the safety controller value after each modification of the temperature set-point. Otherwise, the limit could be too high to ensure efficient protection, or, in the opposite case, it could prevent the controller from reaching an entered set-point outside the limit range.

- **Offset: Effective for für class 2 / 3.1 overtemperature protection and class 3.2 undertemperature protection**

Offset value, over- or undertemperature in relation to the temperature set point.

**Class 2 / 3.1:** Maximum overtemperature above any active temperature set point. The resulting maximum temperature changes internally and automatically with every temperature set-point change. The overtemperature protection is triggered at the set-point plus the offset value.

**Class 3.2:** Minimum undertemperature below any active temperature set point. The resulting minimum temperature changes internally and automatically with every temperature set-point change. The undertemperature protection is triggered at the set-point minus the offset value.

### Example for overtemperature protection:

Desired temperature value: 40 °C, desired safety controller value: 45 °C.

Possible settings for this example:

Temperature set point	Safety controller mode	Safety controller value
40 °C	Limit	Limit value 45 °C
	Offset	Offset value 5 °C





Check the setting regularly and adjust it following changes of the set-point or charge.

### 12.2.3 Setting the safety controller mode

Required access level: "User".

Path: **Normal display**   **Setpoints**    **Safety controller**  **Mode**

Press the **OK button** to enable the setting.

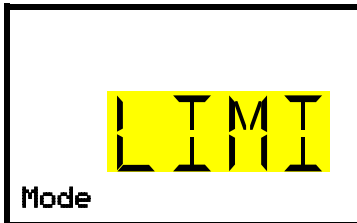

Setting the safety controller mode

The current setting flashes. Use the **arrow buttons** to select between LIMI (Limit) and OFFS (Offset).

Confirm the setting with the **OK button**.



With the **arrow-down button** you proceed to setting the safety controller value (chap. 12.2.4)

With the **Back button** you can go back to the "**Safety controller**" submenu and, repeatedly pressing it, to **Normal display**.

### 12.2.4 Setting the safety controller Limit value for overtemperature

Required access level: "User".

The desired safety controller mode "Limit" must be selected first (chap. 12.2.3).

Path: **Normal display**   **Setpoints**    **Safety controller**   **Limit (high)**

Press the **OK button** to enable the setting.



Setting the safety controller Limit value "Limit high" for overtemperature with safety controller mode "Limit".

The current value flashes. Enter the desired limit value with the **arrow buttons**.

Confirm the entry with the **OK button**.

With the **Back button** you can go back to the "**Safety controller**" submenu and, repeatedly pressing it, to **Normal display**.



Regularly check the settings of the safety controller mode and value.

Set the safety controller value by approx. 2 °C to 5 °C above the desired temperature set-point.

## 12.2.5 Setting the safety controller Offset value for over- and undertemperature

Required access level: "User".

The desired safety controller mode "Offset" must be selected first (chap. 12.2.3).

Path: **Normal display** ▾ ▾ **Setpoints**  ▾ ▾ ▾ **Safety controller**  ▾ **Offset**

Press the **OK button** to enable the setting.

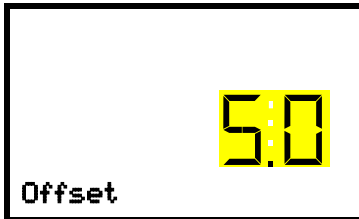

Setting the safety controller Offset value for over- and undertemperature with "Offset" safety controller mode.

The current value flashes. Enter the desired offset value with the **arrow buttons**.

Confirm the entry with the **OK button**.

With the **Back button** you can go back to the "**Safety controller**" submenu and, repeatedly pressing it, to **Normal display**.



Regularly check the settings of the safety controller mode and value.

Set the safety controller value by approx. 2 °C to 5 °C above the desired temperature set-point.

The offset value affects the over- and under-temperature protection.

## 12.3 Safety controller class 3.2 (undertemperature protection)

You have the option of setting an under-temperature protection. This limits the lowest temperature to the value entered here. This value depends on the selected safety controller mode:

- Safety controller mode "Offset": The undertemperature protection is triggered at the set-point minus the offset value. Example: Setpoint 40 °C and offset value 5K results in a trigger value of 35 °C.

For setting the offset value, see chap. 12.2.5.

- Safety controller mode "Limit": The trigger value for the undertemperature protection can be set in the controller menu under "Limit (low)".

### 12.3.1 Setting the safety controller value for undertemperature protection with safety controller mode "Limit"

Required access level: "Admin".

Path: **Normal display** ▾ ▾ ▾ ▾ ▾ **Settings**  ▾ ▾ ▾ **Various**  ▾ ▾ ▾ **Limit (low)**

Press the **OK button** to enable the setting.

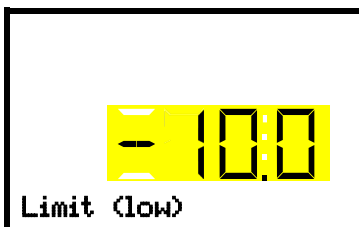

Setting the undertemperature protection.

The current value flashes. Enter the desired minimum temperature value with the **arrow buttons**. Factory setting: -10 °C / 14 °F

Confirm the entry with the **OK button**.

With the **Back button** you can go back to the "**Various**" submenu and, repeatedly pressing it, to **Normal display**.

## 12.4 Message and measures in the state of alarm

The state of alarm is indicated visually in Normal display. If the buzzer is enabled (chap. 15.3) there is an additional audible alert.

- Class 2: The heaters are turned off. As soon as the inner chamber temperature has cooled down below the safety controller value, the heaters can be released
- Class 3.1: The heaters are turned off. As soon as the inner chamber temperature has cooled down below the safety controller value, the heaters are released and temperature control continues.
- Class 3.2: The refrigerating system is turned off. As soon as the inner chamber temperature has risen above below the safety controller value, the refrigerating system is released and temperature control continues.

In Normal display a text message indicates the alarm cause. The “collective alarm” icon is lit. If the audible arm is activated, the buzzer sounds. Press the **OK button** to mute the buzzer.

The alarm message “Safety controller (high)” or “Safety controller (low)” and the “Collective alarm” icon are displayed on the controller until you press the **OK button** on the controller **and** the inner chamber temperature has cooled down below the safety controller value.

- If the inner chamber temperature has already cooled down below the safety controller value when pressing the **OK button**, the alarm message “Safety controller (high)” or “Safety controller (low)” and the “Collective alarm” icon are reset together with the buzzer.
- If the state of alarm is still active when pressing the **OK button**, i.e. the inner chamber temperature is still above the safety controller value, first only the buzzer is reset. The alarm message “Safety controller (high)” or “Safety controller (low)” and the “Collective alarm” icon will disappear as soon as the inner chamber temperature falls below the safety controller value or rises above the trigger value of the undertemperature protection



Normal display showing overtemperature safety controller alarm (sample values)

**Note:** When the safety controller had been activated you should disconnect the chamber from the power supply and have an expert examine and rectify the cause of the fault.

## 12.5 Function check

Check the safety controller at appropriate intervals for its functionality. It is recommended that the authorized operating personnel should perform such a check, e.g., before starting a longer work procedure.

## 13. General controller settings

The general settings can be accessed in the “**Settings**” submenu, which is available for users with “Service” or “Admin” authorization level. It serves to enter date and time, select the language for the controller menus and the desired temperature unit and to configure the controller’s communication functions.

The display of some network settings is available for all users in the “**Chamber info**” menu.

### 13.1 Selecting the controller’s menu language

The RD4 controller communicates by a menu guide using real words in German, English, French, Spanish, and Italian languages.

Required access level: “Admin”. Following start-up of the chamber (chap. 6), it is “User”.

Path: **Normal display**      **Settings**  **Chamber**    **Language\***

\* Following start-up of the chamber: **Sprache / Language / Langue / Idioma / Lingua**, depending on the language selected before turning off the chamber

Press the **OK button** to enable the setting.

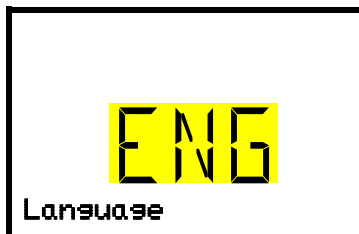

Setting the menu language (example: English).

The current setting flashes. Use the **arrow buttons** to select the desired language.

Confirm the entry with the **OK button**.

With the **arrow-down button (twice)** you can now change to the temperature unit setting.

With the **Back button** you can go back to the “**Chamber**” submenu and, repeatedly pressing it, to **Normal display**.

### 13.2 Selecting the temperature unit

Required access level: “Admin”. Following start-up of the chamber (chap. 6), it is “User”.

Path: **Normal display**      **Settings**  **Chamber**      **Temperature unit**

Press the **OK button** to enable the setting.

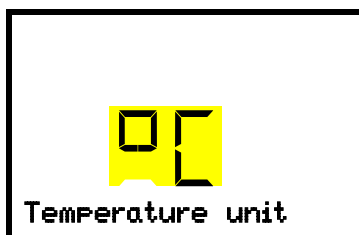

Setting the temperature unit

The current setting flashes. Use the **arrow buttons** to select between °C (degrees Celsius) and °F (degrees Fahrenheit).

Confirm the entry with the **OK button**.

You can change the temperature unit between °C and °F.

If the unit is changed, all values are converted accordingly

	C = degree Celsius	0 °C = 32 °F	Conversion: [value in °F] = [value in °C] * 1,8 + 32
	F = degree Fahrenheit	100 °C = 212 °F	

With the **Back button** you can go back to the “**Chamber**” submenu and, repeatedly pressing it, to **Normal display**.

### 13.3 Setting the current date

Required access level: "Admin". Following start-up of the chamber (chap. 6), it is "User".

Path: **Normal display** ▾ ▾ ▾ ▾ ▾ **Settings**  **Chamber**  **Date**

Press the **OK button** to enable the setting.



Setting the date: day  
The current setting flashes. Enter the current day with the **arrow buttons**.  
Confirm the entry with the **OK button**.

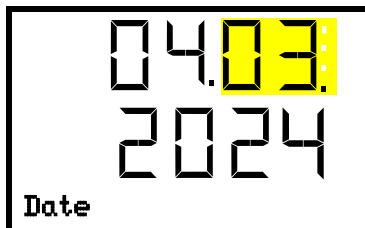

Setting the date: month  
The current setting flashes. Enter the current month with the **arrow buttons**.  
Confirm the entry with the **OK button**.

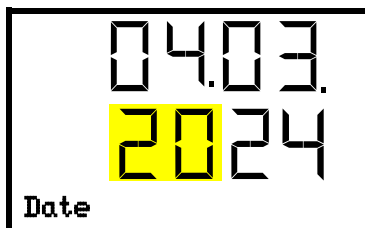

Setting the date: year  
The left two digits are flashing. Enter the first two digits of the current year with the **arrow buttons**.  
Confirm the entry with the **OK button**.

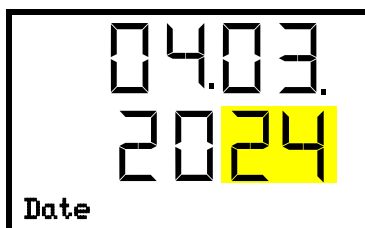

Setting the date: year  
The right two digits are flashing. Enter the last two digits of the current year with the **arrow buttons**.  
Confirm the entry with the **OK button**.

With the **arrow-down button** you can now change to setting the current time.

With the **Back button** you can go back to the "Chamber" submenu and, repeatedly pressing it, to **Normal display**.

### 13.4 Setting the current time

Required access level: "Admin". Following start-up of the chamber (chap. 6), it is "User".

Path: **Normal display** ▾ ▾ ▾ ▾ ▾ **Settings**  **Chamber**  **Time**

Press the **OK button** to enable the setting.

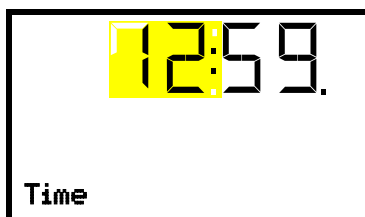

Setting the time: hours  
The current setting flashes. Enter the current hour with the **arrow buttons**.  
Confirm the entry with the **OK button**.

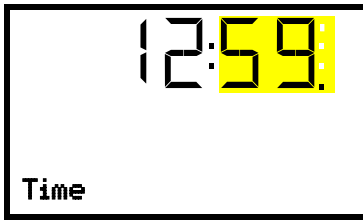

Setting the time: minutes  
The current setting flashes. Enter the current minutes with the **arrow buttons**.  
Confirm the entry with the **OK button**.

With the **Back button** you can go back to the “**Chamber**” submenu and, repeatedly pressing it, to **Normal display**.

### 13.5 Function “Language selection at restart”

If the function “Language selection at restart” is activated, menu language, date, time, and temperature unit are checked with every startup of the chamber. At this occasion it is also possible to modify them with “User” access level.

Required access level: “Admin”.

Path: **Normal display**      **Settings**  **Chamber**     **Language selection at re-start**

Press the **OK button** to enable the setting.



Function “Language selection at restart”  
The current setting flashes. Use the **arrow buttons** to select between ON and OFF.  
Confirm the setting with the **OK button**.

With the **arrow-down button** you can now change to the next parameter (chamber address).

With the **Back button** you can go back to the “**Chamber**” submenu and, repeatedly pressing it, to **Normal display**.

### 13.6 Setting the chamber address

This setting is required for the communication with the BINDER APT-COM™ 4 Multi Management Software. The chamber address settings in the chamber controller and in the software must be identical.

Required access level: “Admin”.

Path: **Normal display**      **Settings**  **Chamber**      **Chamber address**

Press the **OK button** to enable the setting.



Setting the chamber address  
The current setting flashes. Enter the desired address with the **arrow buttons**. Setting range: 1 up to 254  
Confirm the entry with the **OK button**.

With the **arrow-down button** you can now change to the next parameter (display brightness).

With the **Back button** you can go back to the “**Chamber**” submenu and, repeatedly pressing it, to **Normal display**.

## 13.7 Display brightness

Required access level: "Admin".

Path: **Normal display** ▾ ▾ ▾ ▾ ▾ **Settings**  **Chamber**  ▾ ▾ ▾ ▾ ▾ **Brightness**

Press the **OK button** to enable the setting.



Setting the display brightness

The current setting flashes. Enter the desired value with the **arrow buttons**. Setting range: 10% up to 100%

Confirm the entry with the **OK button**.

With the **arrow-down button** you can now change to the next parameter (audible alarm, chap. 15.3).

With the **Back button** you can go back to the "**Chamber**" submenu and, repeatedly pressing it, to **Normal display**.

## 14. Tolerance range settings

In this menu you can define the deviation between the actual value and setpoint, which that shall cause a tolerance range alarm. The entered value defines the limit of permitted deviations from the set-point (exceeding and falling below). Reaching this limit triggers tolerance alarm.

In addition, you can specify a delay time for this alarm.

If the actual value is outside the tolerance range, after the configured alarm delay time the alarm message "Temperature range" is displayed in Normal display (chap. 15.2). If the alarm buzzer is activated (chap. 15.3) there is an audible alert.

This function only activates after the set-point has been reached once.

Required access level: "Admin".

### 14.1 Setting the delay time for tolerance range alarm

Path: **Normal display** ▾ ▾ ▾ ▾ ▾ **Settings**  ▾ ▾ ▾ **Various**  **Range alarm delay (min)**

Press the **OK button** to enable the setting.



Setting the tolerance range alarm delay.







The current setting flashes. Use the **arrow buttons** to enter the desired time after which the range alarm shall be triggered. Entry range: 1 up to 300 minutes. Factory setting: 60 minutes.

Confirm the entry with the **OK button**.

With the **arrow-down button** you can now change to the temperature tolerance range setting.

With the **Back button** you can go back to the "**Various**" submenu and, repeatedly pressing it, to **Normal display**.

## 14.2 Setting the temperature tolerance range

Path: **Normal display**      **Settings**     **Various**   **Temperature range**

Press the **OK button** to enable the setting.

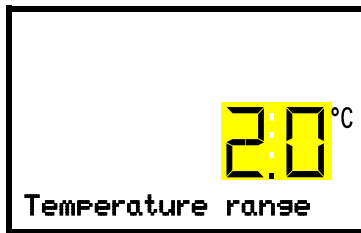

Setting the temperature tolerance range  
The current setting flashes. Enter the desired temperature range with the **arrow buttons**. Entry range: 1.0 °C up to 10.0 °C  
Confirm the entry with the **OK button**.

With the **arrow-up button** you can go back to the tolerance range alarm delay setting.

With the **Back button** you can go back to the “**Various**” submenu and, repeatedly pressing it, to **Normal display**.

## 15. Notification and alarm functions

### 15.1 Information messages

Information messages provide information about the settings made or the current controller condition. The message is displayed immediately when the condition occurs.



In Normal display a text message indicates the condition. The “Information” icon is flashing slowly.

To confirm the information message, press the **OK button**.

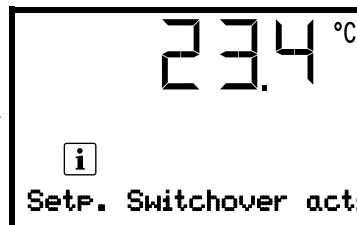
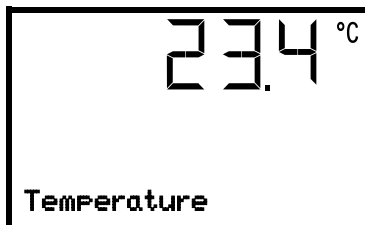

Normal Display showing the information message  
(example: active alternative setpoint / sample values)

If there are several information messages, they are displayed one after the other.

#### Information messages overview:





Condition	Information message
“Idle Mode”function has been activated in the „Functions on/off“ menu	“Idle Mode”
The current actual temperature value is outside the tolerance range (chap. 14)	“Temperature range” alternating with “Setpoint: *** °C”
The automatic setpoint switchover has been activated. The information text “Setpoint switchover active” is shown alternating with “Temperature” in Normal Display (chap. 9).	“Setp. Switchover active”
Hot-air disinfection running	“Disinfection”
Hot-air disinfection successfully completed	“Disinfection successful”
Recommended maintenance interval (one year of operation) is over. This message is displayed after each week of operating time once the maintenance interval has expired	“Service due!”



Press the **OK button** to confirm the information message.

Additionally, the activated functions are indicated by an icon in Normal display showing the number of the respective function.

**Overview of the information icons of the activated controller functions:**

Condition	Information icon in Normal display
Function 1 Idle Mode has been activated in the “Functions on/off” menu	
Function 2 Object temperature control has been activated in the “Functions on/off” menu	
Function 3 Door lock has been activated in the “Functions on/off” menu	
Function 4 Continuous internal light has been activated in the “Functions on/off” menu	

If several functions are simultaneously active, the icon displays a combination of the corresponding numbers, e.g. 

## 15.2 Alarm messages

In the event of equipment failures, when the temperature deviate from the set tolerance range limits, and with activated self-test function, optical and possibly acoustic alarm messages are given out via the controller.



In Normal display a text message indicates the alarm cause. The “collective alarm” icon flashes. If the audible arm is activated, the buzzer sounds.

Press the **OK button** to confirm the alarm and mute the buzzer. If the alarm cause is still valid, the “collective alarm” icon is lit.



Alarm indication (example: overtemperature safety controller alarm)

### Alarm messages overview:

Condition	Alarm message	Start after condition occurred
The current actual temperature value is outside the tolerance range (chap. 14)	"Temperature range alarm"	after configurable time
Setpoint of the safety controller exceeded	"Safety controller (high)"	immediately
Trigger value of the safety controller fallen below	"Safety controller (low)"	immediately
Self-test function is active	"Self-test active"	immediately
Self-test completed	"Self-test finished"	immediately
Temperature sensor defective	e.g. "- - - -" "or" "<-<-<" or ">->->"	immediately
Door temperature sensor defective	"Door sensor"	immediately
Safety controller temperature sensor defective	"Safety controller sensor"	immediately

Press the **OK button** to confirm the alarm.

- Confirmation while the state of alarm persists: Only the buzzer is muted. The visual alarm message continues to be displayed until the alarm condition is removed. Then it is reset automatically.
- Confirmation after the alarm has ended: The buzzer and the visual alarm message are reset together.

### 15.3 Activating / deactivating the audible alarm (alarm buzzer)

Path: **Normal display**      **Settings**  **Chamber**         **Audible alarm**

Press the **OK button** to enable the setting.



Setting the audible alarm.

The current setting flashes. Use the **arrow buttons** to select between ON and OFF.

Confirm the setting with the **OK button**.

With the **Back button** you can go back to the "**Chamber**" submenu and, repeatedly pressing it, to **Normal display**.

## 16. Ethernet network settings

The settings of this submenu are used for networking chambers with an Ethernet interface, e.g. to connect them with BINDER's APT-COM™ 4 Multi Management Software (option, chap. 22.1).

### 16.1 Showing the network settings

Required access level: "User".

The "Ethernet" submenu offers to subsequently or individually access the following information:

- MAC address
- IP address
- Subnet mask
- Standard gateway
- DNS server address
- DNS chamber name

#### 16.1.1 Showing the chamber's MAC address

Path: **Normal display** ▾ ▾ ▾ ▾ **Chamber info**  ▾ ▾ ▾ ▾ ▾ ▾ ▾ **Ethernet**  **MAC address**

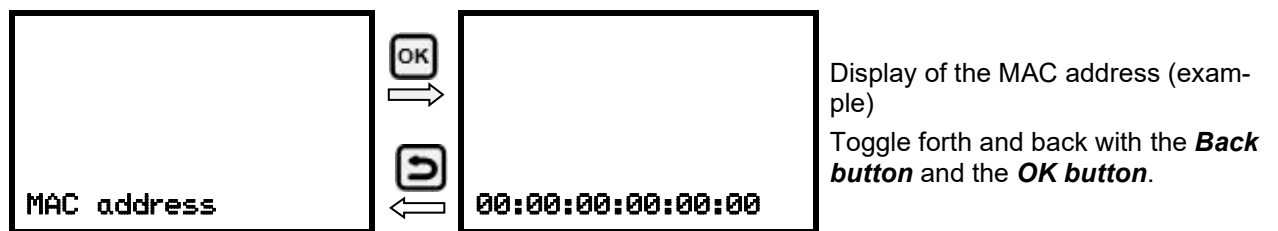

With the **arrow-down button** you can now change to the next parameter (IP address).

With the **Back button** you can go back to the "Ethernet" submenu and, repeatedly pressing it, to **Normal display**.

#### 16.1.2 Showing the IP address

Path: **Normal display** ▾ ▾ ▾ ▾ **Chamber info**  ▾ ▾ ▾ ▾ ▾ ▾ ▾ **Ethernet**  **IP address**



With the **arrow-down button** you can now change to the next parameter (subnet mask).

With the **Back button** you can go back to the "Ethernet" submenu and, repeatedly pressing it, to **Normal display**.

### 16.1.3 Showing the subnet mask

Path: **Normal display** ▾ ▾ ▾ ▾ **Chamber info**  ▾ ▾ ▾ ▾ ▾ ▾ ▾ **Ethernet**  ▾ ▾ **Subnet mask**

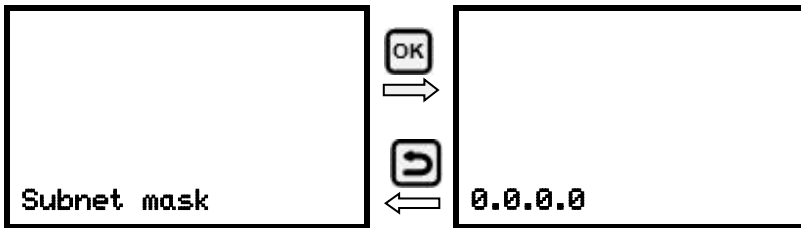

Display of the subnet mask (example)  
Toggle forth and back with the **Back button** and the **OK button**.

With the **arrow-down button** you can now change to the next parameter (standard gateway).

With the **Back button** you can go back to the "Ethernet" submenu and, repeatedly pressing it, to **Normal display**.

### 16.1.4 Showing the standard gateway

Path: **Normal display** ▾ ▾ ▾ ▾ **Chamber info**  ▾ ▾ ▾ ▾ ▾ ▾ ▾ **Ethernet**  ▾ ▾ ▾ **Standard gateway**

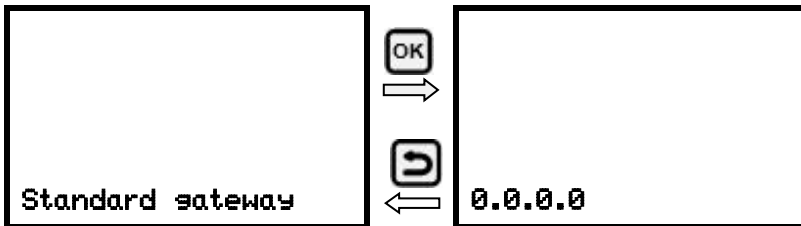

Display of the standard gateway (example)  
Toggle forth and back with the **Back button** and the **OK button**.

With the **arrow-down button** you can now change to the next parameter (DNS server address).

With the **Back button** you can go back to the "Ethernet" submenu and, repeatedly pressing it, to **Normal display**.

### 16.1.5 Showing the DNS server address

Path: **Normal display** ▾ ▾ ▾ ▾ **Chamber info**  ▾ ▾ ▾ ▾ ▾ ▾ ▾ **Ethernet**  ▾ ▾ ▾ ▾ **DNS server address**

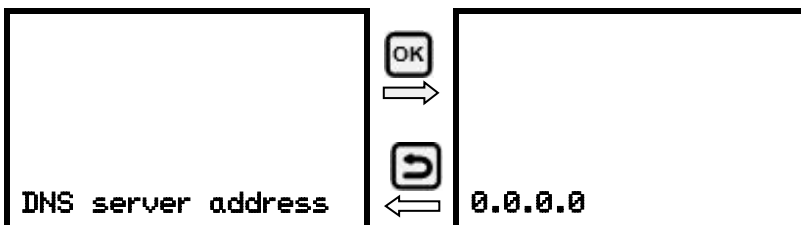

Display of the DNS server address (example)  
Toggle forth and back with the **Back button** and the **OK button**.

With the **arrow-down button** you can now change to the next parameter (DNS chamber name).

With the **Back button** you can go back to the "Ethernet" submenu and, repeatedly pressing it, to **Normal display**.

### 16.1.6 Showing the DNS chamber name

Path: **Normal display** ▾ ▾ ▾ ▾ **Chamber info**  ▾ ▾ ▾ ▾ ▾ ▾ ▾ **Ethernet**  ▾ ▾ ▾ ▾ ▾  
 ▾ **DNS chamber name**



With the **Back button** you can go back to the “Ethernet” submenu and, repeatedly pressing it, to **Normal display**.

## 16.2 Changing the configuration of the network settings

Required access level: “Admin”.

The “Ethernet” submenu offers to subsequently or individually access the following settings:

- Selecting the type of assignment (automatic or manual) of the IP address, chap. 16.2.1

If automatic IP address assignment has been selected:

- Selecting the type of assignment (automatic or manual) of the DNS server address, chap. 16.2.2

If manual IP address assignment has been selected:

- Assigning the IP address, chap. 16.2.3
- Assigning the subnet mask, chap. 16.2.4
- Assigning the standard gateway, chap. 16.2.5

If manual IP address assignment or manual DNS server address assignment has been selected:

- Assigning the DNS server address, chap. 16.2.6

### 16.2.1 Selecting the type of IP address assignment (automatic / manual)

Path: **Normal display** ▾ ▾ ▾ ▾ ▾ **Settings**  ▾ **Ethernet**  **IP address assignment**

Press the **OK button** to enable the setting

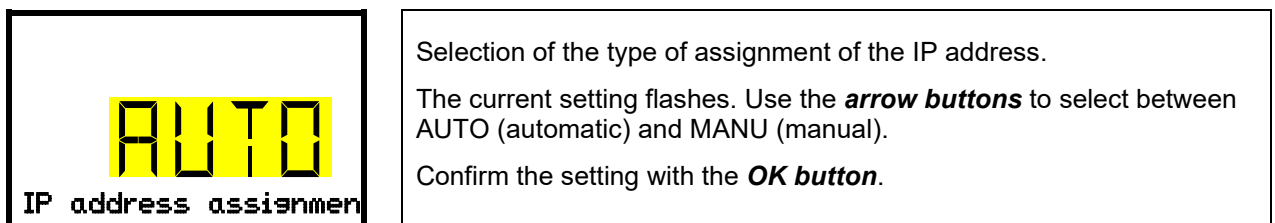

With the **arrow-down button** you can now change to the next parameter.

- If manual IP address assignment has been selected: assign the IP address (chap. 16.2.3)
- If automatic IP address assignment has been selected: select the type of assignment of the DNS server address (chap. 16.2.2).

With the **Back button** you can go back to the “Ethernet” submenu and, repeatedly pressing it, to **Normal display**.

## 16.2.2 Selecting the type of assignment of the DNS server address (automatic / manual)

Access to this function is possible only if automatic IP address assignment has been selected (chap. 16.2.1).

Path: **Normal display** ▾ ▾ ▾ ▾ ▾ **Settings**  **Ethernet**  ▾ ▾ **DNS server**

Press the **OK button** to enable the setting.

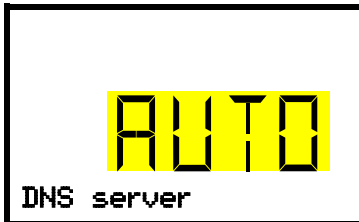

Selection of the type of assignment of the DNS server address.

The current setting flashes. Use the **arrow buttons** to select between AUTO (automatic) and MANU (manual).

Confirm the setting with the **OK button**.

If manual assignment of the DNS server address has been selected, you can now change with the **arrow-down button** to assign the DNS server address (chap. 16.2.6).

With the **Back button** you can go back to the “Ethernet” submenu and, repeatedly pressing it, to **Normal display**.

## 16.2.3 Assigning the IP address

Access to this function is possible only if manual IP address assignment has been selected (chap. 16.2.1)

Path: **Normal display** ▾ ▾ ▾ ▾ ▾ **Settings**  **Ethernet**  ▾ ▾ **IP address**

Press the **OK button** to enable the setting.

The IP address entry is done in four steps, corresponding to the number sections: (1).(2).(3).(4)

Principle of entry:

- Use the **OK button** to select the desired section of the IP address 1/4, 2/4, 3/4, 4/4 in the upper display line
- Use the **Arrow buttons** to enter the value for the selected section of the IP address



IP address assignment (sample values).

The first section of the IP address is shown. Enter the desired value with the **arrow buttons**.

Use the **OK button** to confirm the entry and proceed to the second section of the IP address.

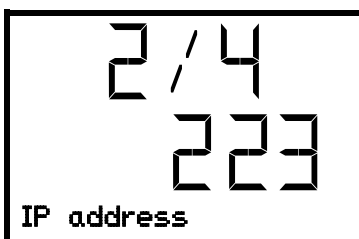

IP address assignment (sample values).

The second section of the IP address is shown. Enter the desired value with the **arrow buttons**.

Use the **OK button** to confirm the entry and proceed to the third section of the IP address.

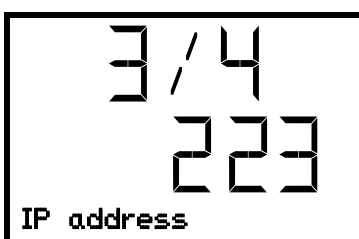

IP address assignment (sample values).

The third section of the IP address is shown. Enter the desired value with the **arrow buttons**.

Use the **OK button** to confirm the entry and proceed to the last section of the IP address.



IP address assignment (sample values).

The fourth section of the IP address is shown. Enter the desired value with the **arrow buttons**.

Confirm the setting with the **OK button**.

With the **arrow-down button** you can now change to the enter the subnet mask.

With the **Back button** you can go back to the “Ethernet” submenu and, repeatedly pressing it, to **Normal display**.

### 16.2.4 Setting the subnet mask

Access to this function is possible only if manual IP address assignment has been selected (chap. 16.2.1)

Path: **Normal display**      **Settings**   **Ethernet**     **Subnet mask**

Press the **OK button** to enable the setting.

The subnet mask entry is done in four steps, corresponding to the number sections: (1).(2).(3).(4)

Principle of entry:

- Use the **OK button** to select the desired section of the subnet mask 1/4, 2/4, 3/4, 4/4 in the upper display line
- Use the **Arrow buttons** to enter the value for the selected section of the subnet mask

For details please refer to the description of the similar procedure in chap. 16.2.3 “Assigning the IP address”.

With the **arrow-down button** you can now change to the enter the standard gateway.

With the **Back button** you can go back to the “Ethernet” submenu and, repeatedly pressing it, to **Normal display**.

### 16.2.5 Setting the standard gateway

Access to this function is possible only if manual IP address assignment has been selected (chap. 16.2.1)

Path: **Normal display**      **Settings**   **Ethernet**     **Standard gateway**

Press the **OK button** to enable the setting.

The standard gateway entry is done in four steps, corresponding to the number sections: (1).(2).(3).(4)

Principle of entry:

- Use the **OK button** to select the desired section of the standard gateway 1/4, 2/4, 3/4, 4/4 in the upper display line
- Use the **Arrow buttons** to enter the value for the selected section of the standard gateway
- For details please refer to the description of the similar procedure in chap. 16.2.3 “Assigning the IP address”.

With the **arrow-down button** you can now change to the assign the DNS server address.

With the **Back button** you can go back to the “Ethernet” submenu and, repeatedly pressing it, to **Normal display**.

## 16.2.6 Assigning the DNS server address

Access to this function is possible if manual IP address assignment (chap. 16.2.1) or manual DNS server address assignment (chap. 16.2.2) has been selected.

With manual IP address assignment:

Path: **Normal display**      **Settings**   **Ethernet**      **DNS server address**

With manual DNS server address assignment:

Path: **Normal display**      **Settings**   **Ethernet**    **DNS server address**

Press the **OK button** to enable the setting.

The DNS server address entry is done in four steps, corresponding to the number sections: (1).(2).(3).(4)

Principle of entry:

- Use the **OK button** to select the desired section of the DNS server address 1/4, 2/4, 3/4, 4/4 in the upper display line
- Use the **Arrow buttons** to enter the value for the selected section of the DNS server address
- For details please refer to the description of the similar procedure in chap. 16.2.3 "Assigning the IP address".

With the **Back button** you can go back to the **"Ethernet"** submenu and, repeatedly pressing it, to **Normal display**.

## 17. Data recorder

An internal data recorder saves chamber data and events in three data sets.

With the export function "Export recorder data" (chap. 18.3) you can save the three data sets via the USB interface to USB stick. They are issued in the selected language as a spreadsheet with the file extension ".csv" and can be further processed in the desired program. The data is unencrypted. Always the entire data memory is read out.

### 17.1 Recorded data

All data is given out in tabular form. The headlines of the values "number", "date", and "time" are given out in the selected language, all other information in English.

- **Chamber data for the user "DL1"**

Tabular representation of the actual temperature values and object temperature values (option) together with the date and time, according to the set storage rate (chap. 17.3). Temperature values are always given out in °C.

- **Chamber data for BINDER Service "DL2"**

This data is intended for use by BINDER Service. It also contains information from the self-test function. The storage rate is fix (1 minute). Temperature values are always given out in °C.

- **Event list**

Messages regarding the controller and data memory as well as the alarm messages together with the date and time:

- Firmware update done
- "New config (USB)": New configuration uploaded via USB
- "Data recorder cleared": Data recorder and event list deleted via setup program



- Other event messages according to existing alarms
- The moment of switching the alarm state on and off is indicated under “On/Off”.

## 17.2 Storage capacity

The storage capacity of the data recorder depends on the number of entries.

- DL1 = 110.000 entries (equaling 76 days with a storage rate of 1 minute, setting see chap. 17.3)
- DL2 = 27.000 entries (equaling 18 days with a fix storage rate of 1 minute)
- Event list: 200 events

The shorter the set storage rate, the closer are the stored measuring points, the more precise, but also shorter is the documented period.

Once the storage capacity of the data recorder is reached, overwriting of the oldest values begins

## 17.3 Setting the storage rate for the “DL1” recorder data

Required access level: “Admin”.

Path: **Normal display** ▾ ▾ ▾ ▾ ▾ **Settings**  ▾ ▾ **Data recorder**  **Storage interval**

Press the **OK button** to enable the setting.

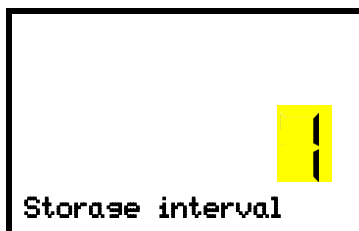

Function “Storage interval”.

The current setting flashes. Use the **arrow buttons** to enter the desired storage interval. Setting range: 1 minute to 60 minutes.

Press the **OK button** to confirm the setting.

With the **Back button** you can go back to the “**Data recorder**” submenu and, repeatedly pressing it, to **Normal display**.

## 17.4 Deleting the data recorder

When importing a configuration via USB stick and when loading a new firmware version by BINDER service, the entire data memory is deleted.

BINDER service can also install the configuration by means of a setup program without deleting the data.

Regardless of this, BINDER Service can delete the data via a setup program.

Loading a new configuration via USB-Stick leads to deleting the data recorder.

	NOTICE
	<p><b>Danger of information loss when loading a new configuration.</b>  <b>Information loss.</b></p> <p>➤ Backup data prior to loading a new configuration.</p>

## 18. USB menu: Data transfer via USB interface

A USB interface for data transfer via USB stick is located in the instrument box (the second micro USB interface is only used by the manufacturer).

The controller offers an import function and three export functions through the USB interface:

### Import function (chap. 18.2):

- Configuration data in file "KONF380.set"

### Export functions (chap. 18.3):

- Configuration data in file "KONF380.set"
- Recorder data
  - DL1 (chamber data for the user): "DL1\_[MAC address of the chamber].csv"
  - DL2 (chamber data for BINDER Service): "DL2\_[MAC address of the chamber].csv"
  - Event list: "EvList\_[MAC address of the chamber].csv"

For detailed information on the file content see chap. 17.1.

- Service data

The "Service" folder is created on the USB stick and can be sent to BINDER Service. In addition to the configuration and recorder data, it contains further service-relevant information.

### 18.1 Connecting the USB stick

Connect the USB stick to the interface located in the triangular instrument panel.



Connect only USB sticks to the USB interface.  
The USB stick must be formatted with FAT32 and have at least 8GB of memory.

After inserting the USB stick, the initial function "Import configuration" is displayed.

As long as the USB stick is connected, only the functions for data transfer are available. Other controller functions are only available after removing the USB stick.

### 18.2 Import function

Required access level: "Admin".



Function "Import configuration".

To import configuration data from the USB stick, press the **OK button**.

With the **arrow-down button** you can now change to the setting of the "Export configuration" function.

### 18.3 Export functions

Required access level: any user



Function "Export configuration".

To write the configuration data from the controller to the USB stick, press the **OK button**.

With the **arrow-down button** you can now change to the next function.



Function "Export recorder data".

To write the recorder data from the controller to the USB stick, press the **OK button**.

With the **arrow-down button** you can now change to the next function.



Function "Export service data".

To write the chamber data from the controller to the USB stick, press the **OK button**.

### 18.4 Ongoing data transfer

A moving arrow symbol indicates the progress of the data transfer.

Example:



Data recording is running.

Attention! Danger of data loss! Do not disconnect the USB stick from the device during ongoing data transfer!

After successful transfer, the controller shows again the initial function "Import configuration".

### 18.5 Error during data transmission

In the event of an error, the message ERR (error) is displayed.



Read error (example).

## 18.6 Removing the USB stick

Logging off the USB stick is not possible / required.

Be sure that no data recording is running (chap. 18.4).

After removing the USB stick, the controller is back in the same menu as before when connecting the USB stick.

## 19. Self-test function

The self-test function enables an automated check of the proper chamber functioning as well as a targeted and reliable fault analysis. In this case, the chamber successively undergoes various defined operating states, which serves to determine reproducible characteristic values. These characteristic values provide information on the performance and precision of the individual functional systems of the chamber (e.g., heating, refrigeration) of the chamber.

The results of the self-test are stored in the service recorder of the controller. You can export them using the controller's USB interface and send them to BINDER Service (use function "Export recorder data" to USB stick, chap. 18). BINDER Service will evaluate the data using an analyzing tool.

	<p>In order to allow an optimum comparison of the determined characteristic values with the reference characteristic values, the ambient temperature should be in the range of <math>+22\text{ °C} \pm 3\text{ °C} / 71.6\text{ °F} \pm 5.4\text{ °F}</math>.</p> <p>The chamber shall be unloaded (empty with standard equipment).</p>
---	---

### 19.1 Activating the self-test function

Required access level: "Admin".

Path: **Normal display**      **Settings**     **Various**        

**Self-test**

Press the **OK button** to enable the settings.

Following, you can choose between the following settings:

- "0" (function off)
- "1" (self-test; duration: 12-18 hours)



Setting the self-test function

The current setting flashes. Use the **arrow buttons** to select the setting "1" to activate the self-test function.

Confirm the setting with the **OK button**.

Press the **Back button** several times to go back to **Normal display**.

In Normal display the activated Self-test function is shown. The "Collective alarm" icon is lit. The entered setpoint values are inactive, the stored test program is running. With activated audible signal: The buzzer sounds. Press the **OK button** to mute the buzzer.

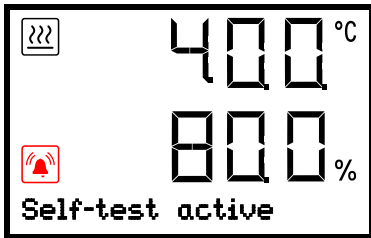

Display showing the running self-test in Normal display (example values)



Do not open and do not turn off the chamber while self-test is running. After an interruption of the voltage supply, the self-test restarts.

If desired, you can cancel an ongoing self-test by deactivating the self-test function in the controller menu (chap. 19.2).

When the complete self-test has finished, the message “Self-test completed” appears. The setpoint values become active again



Display showing the completed self-test in Normal display (example values)

To delete the alarm message then deactivate the self-test function (chap. 19.2).

## 19.2 Deactivating the self-test mode

You can deactivate the self-test mode via the controller menu:

- cancel the running self-test prematurely
- to delete the alarm message after completing the entire self-test

The procedure is similar to activating the self-test function.

Required access level: “Admin”.

Path: **Normal display** ▾ ▾ ▾ ▾ ▾ **Settings**  ▾ ▾ ▾ **Various**  ▾ ▾ ▾ ▾ ▾ ▾ ▾ **Self-test**

Press the **OK button** to enable the settings.



Configuring the self-test function

The current setting flashes. To deactivate the self-test function, select the setting “0” with the **Arrow buttons**.

Confirm the setting with the **OK button**.

Press the **Back button** several times to go back to **Normal display**.

## 20. Defrosting at refrigerating operation

BINDER cooling incubators are very diffusion-proof. In favor of the high temperature accuracy, no automatic cyclical defrosting device is used. At very low temperatures the moisture in the air can condense on the cooling surfaces leading to icing.



Always close the door properly.

**Operation with temperature set-points above +5 °C / 41 °F at an ambient temperature of 25 °C / 77 °F:**

The air defrosts the ice cover automatically. Defrosting is continually performed.

**Operation with temperature set-points below +5 °C / 41 °F:**

Icing on the cooling surfaces is possible. Defrost the chamber manually.



With temperature set-points below +5 °C / 41 °F, regularly defrost the chamber manually:

- Set the temperature to 40 °C / 104 °F.
- Let the chamber operate for about 30 minutes with the door closed.



Too much ice on the cooling surfaces is noticeable by reduced refrigerating performance.

## 21. Anti-condensation protection

Depending on the load, for example with a large number of Petri dishes, a lot of moisture can be released in the interior of the chamber.

The anti-condensation protection can be used to increase the heating in the chamber edge and door area to prevent condensation in this area. This way the anti-condensation protection prevents condensation/icing even at low temperatures.

This can result in increased energy consumption and poorer spatial temperature distribution.

In addition, a constant cooling output is generated, which limits the air humidity.

With the “Anti-condensation protection” function, you can adjust the intensity of the anti-condensation protection.

Path: **Normal display**      **Settings**     **Various**    **Anti-condensation**

Press the **OK button** to enable the setting.



Setting the anti-condensation protection

The current setting flashes. Enter the desired intensity of the anti-condensation protection with the **arrow buttons**. Entry range: 0 % up to 100 %.

Confirm the entry with the **OK button**.

With the **arrow-up button** you can go back to the temperature tolerance range setting (chap. 14.2).

With the **Back button** you can go back to the “**Various**” submenu and, repeatedly pressing it, to **Normal display**.

### Information on the setting

Factory setting is 50% intensity. This setting is suitable for most applications.

## 22. Options and accessories

### 22.1 APT-COM™ 4 Multi Management Software (accessory)

The chamber is regularly equipped with an Ethernet interface (N) that can connect the BINDER APT-COM™ 4 Multi Management Software. The MAC Address is indicated in the “Ethernet” controller menu (chap. 16.1.1). The actual temperature values are given at adjustable intervals. Programming can be performed graphically via PC. Up to 100 chambers can be cross-linked. For further information please refer to the APT-COM™ 4 operating manual.

### 22.2 Analog outputs for temperature (option)

With this option the chamber is equipped with analog outputs 4-20 mA for temperature. These outputs permit transmitting data to external data registration systems or devices.

The connection is realized as socket (I) as follows:

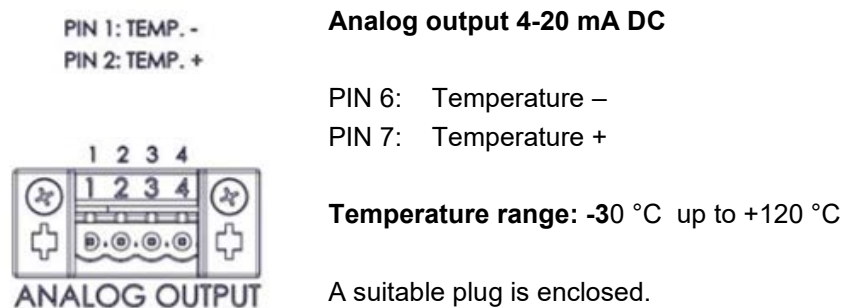

Figure 13: Pin configuration of the socket “ANALOG OUTPUT” (I) for the analog outputs option

### 22.3 Zero-voltage alarm contacts for collective alarm output (option)

If the chamber is equipped with zero-voltage relay contacts for collective alarm output (option), the alarm functions can be transmitted to an external monitoring system. The connection is realized as as socket (J) in the control panel on the chamber rear.

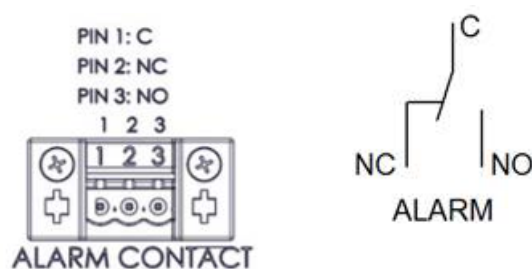

Figure 14: Pin configuration of the socket “ALARM CONTACT” (J) for zero-voltage alarm contacts



The zero-voltage relay alarm output switches immediately, as soon as the Collective alarm icon lights up on the controller display. The zero-voltage relay alarm output switches for all alarm instances and in case of a power failure.

If the external alarm monitor is connected via the contacts C and NO, alarm monitoring will take place with protection against short-circuiting, i.e., if the connection between the chamber and the external alarm monitor is interrupted, an alarm is triggered. In this case, power failure will also trigger the alarm.

When the chamber is running and there is no alarm, contact C closes with contact NO.

When the chamber is turned off or if there is an active alarm, contact C closes with contact NC.

Maximum loading capacity of the switching contacts: 24V AC/DC – 2.5 Amp.

	 <b>DANGER</b>
	<p><b>Electrical hazard through overload of switching contacts.</b>  <b>Deadly electric shock. Damage to switching contacts and connection socket.</b></p> <ul style="list-style-type: none"> <li>∅ Do NOT exceed the maximum switching load of 24V AC/DC – 2.5 Amp.</li> <li>∅ Do NOT connect any devices with a higher loading capacity.</li> </ul>

The alarm message on the controller display remains displayed during transmission of an alarm via the zero-voltage relay outputs. As soon as the cause of the alarm is rectified, or the alarm message has been reset, the alarm transmission via the zero-voltage relay outputs is reset together with the alarm message on the controller display.

In case of power failure, transmission of the alarm via zero-voltage relay outputs remains active for the duration of the power failure. Afterwards, both contacts close automatically.

	<p>When using the APT-COM™ 4 Multi Management Software (option, chap. 22.1) via the interface of the constant climate chamber for data acquisition, the alarm is not automatically transmitted to the APT-COM™ protocol.</p> <ul style="list-style-type: none"> <li>➤ Set the tolerance limits for recording limit value excesses separately in APT-COM™ 4.</li> </ul>
---	--

### Connection to an external monitoring system

To ensure short-circuit-proof alarm monitoring that will trigger the alarm when connected to an external alarm monitor, connect the external alarm monitoring system to the chamber via the connection socket (J) of the zero-voltage relay output.

## 22.4 Door lock (option)

With this option you can activate and deactivate the door lock via the controller. To do this, call up the "Functions on/off" menu (chap. 8) and select function 3: "Door lock".

When the door lock is activated, the door can only be opened after the "Door lock" function has been deactivated.

Required access level: "User".

Path: **Normal display**   **Setpoints**    **Functions on/off**    **Door lock**

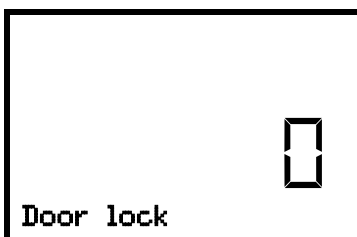

Function 3 "Door lock".  
 The current switching state is shown (example).  
 "1" = Activated function  
 "0" = Deactivated function

Press the **OK button** to enable the setting.

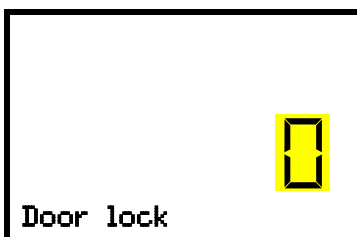

Setting function 3 "Door lock".  
 The current setting flashes. Use the **arrow buttons** to select between 0 (deactivated door lock) and 1 (activated door lock).  
 Confirm the setting with the **OK button**.



With the **Back button** you can go back to the “**Functions on/off**” submenu and, repeatedly pressing it, to **Normal display**.

In Normal display the activated function is indicated by an icon showing the number “3”. The “Info” icon flashes slowly. While it is lit, the lower text informs about the activated functions.

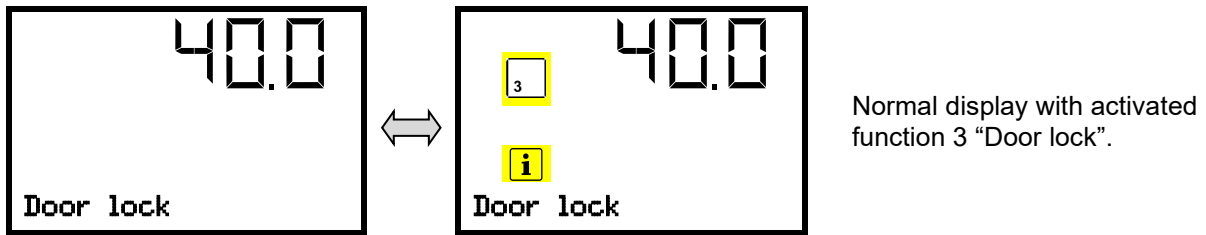







## 22.5 Internal LED light (option)

With this option, the chamber is equipped with automatic internal LED light. By default, the light turns on when the outside door is opened and goes off again when it is closed.

With the “Internal light” controller function, you can switch off the automatic deactivation of the internal light when the door is closed. When the function is activated, the light is permanently on. To do this, call up the “Functions on/off” menu (chap. 8) and select function 4: “Internal light”.

Required access level: “User”.

Path: **Normal display**   **Setpoints**    **Functions on/off**     **Internal light**

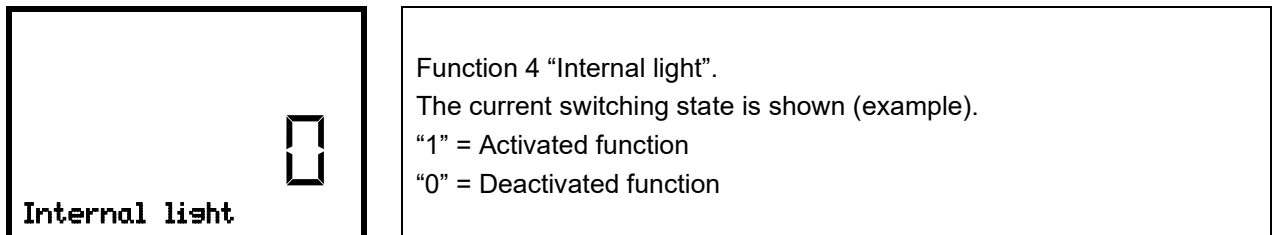

Press the **OK button** to enable the setting.

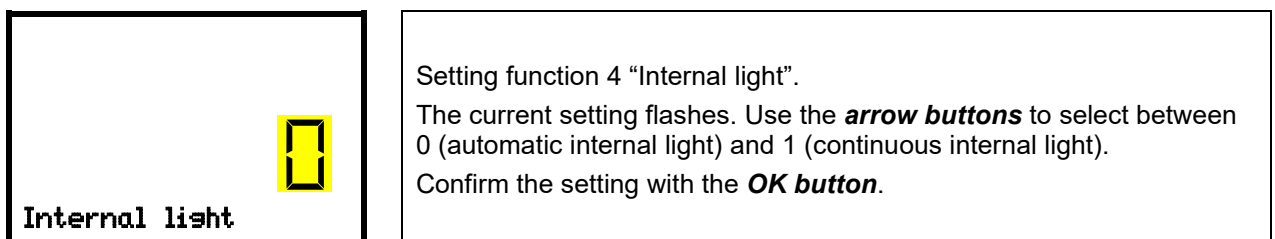

With the **Back button** you can go back to the “**Functions on/off**” submenu and, repeatedly pressing it, to **Normal display**.

In Normal display the activated function is indicated by an icon showing the number “4”. The “Info” icon flashes slowly. While it is lit, the lower text informs about the activated functions.

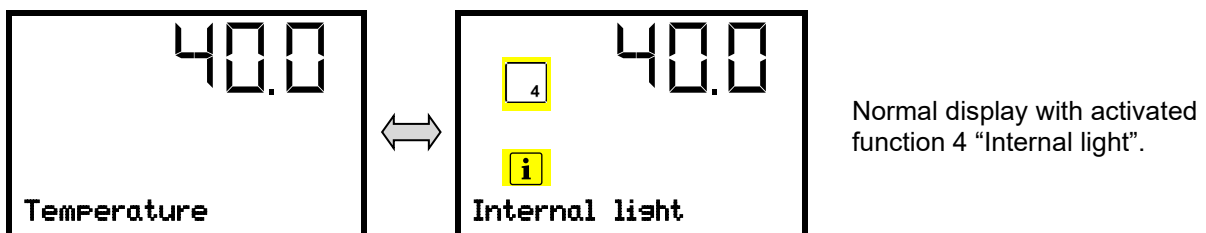

## 22.6 Object temperature control with flexible Pt 100 temperature sensor (option)

**Object temperature display:** During the entire test period, the actual temperature of the load is displayed on the controller. The object temperature is measured via a flexible Pt100 temperature sensor and can be viewed on the controller display. You can immerse the sensor top protective tube of the flexible Pt 100 into liquid substances

With activated **object temperature control** the temperature setpoint is regulated in a way that it is reached inside the load. This is done using the flexible Pt100 temperature sensor, which measures the object temperature, shows it on the controller display and regulates accordingly. You can immerse the sensor top protective tube of the flexible Pt 100 into liquid substances.

### Technical data of the Pt100 sensor:

- Three-wire technique
- Class B (DIN EN 60751)
- Temperature range up to 320 °C / 608°F
- Stainless steel protective tube with a length of 45 mm / 1.78 in, material no. 1.4501

### 22.6.1 Activating/deactivating object temperature control

With this option you can activate and deactivate the object temperature control via the controller. To do this, call up the "Functions on/off" menu (chap. 8) and select function 2: "Object temp. Control".

Required access level: "User".

Path: **Normal display**   **Setpoints**    **Functions on/off**   **Object temp. Control**

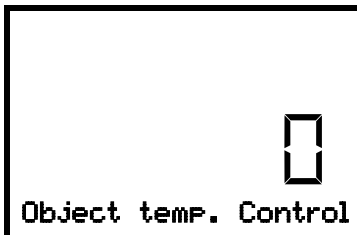

Function 2 "Object temp. Control".  
The current switching state is shown (example).  
"1" = Activated function  
"0" = Deactivated function

Press the **OK button** to enable the setting.

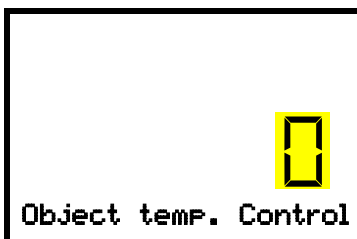

Setting function 2 "Object temp. Control".  
The current setting flashes. Use the **arrow buttons** to select between 0 (deactivated object temperature control) and 1 (activated object temperature control).  
Confirm the setting with the **OK button**.

With the **Back button** you can go back to the "**Functions on/off**" submenu and, repeatedly pressing it, to **Normal display**.

In Normal display the activated function is indicated by an icon showing the number "2". The "Info" icon flashes slowly. While it is lit, the lower text informs about the activated functions.

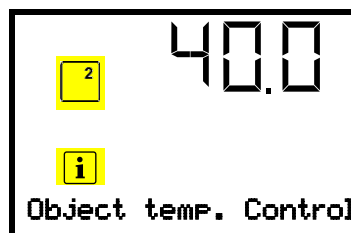
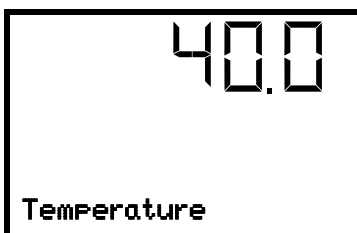

Normal display with activated function 2 "Object temp. Control".

The object temperature data are put out together with the data of the temperature controller and can be documented by the APT-COM™ 4 Multi Management Software (option, chap. 22.1) developed by BINDER.

## 22.6.2 Setting the sensitivity of the object temperature control

The measurement of the air temperature is fast and allows for fast control. Here the sensitivity setting should be 100%.

When measuring directly in the sample, the temperature measurement is delayed / less sensitive, which could lead to problems with fast control (oscillations). Therefore, the speed or sensitivity must be adjusted by setting it to a lower value, e.g. 5-10%.

Required access level: "Admin".

Path: **Normal display** ▾ ▾ ▾ ▾ ▾ **Settings**  ▾ ▾ ▾ **Various**  ▾ ▾ ▾ ▾ ▾ **Obj.-Control Sensitiv.**

Press the **OK button** to enable the setting.

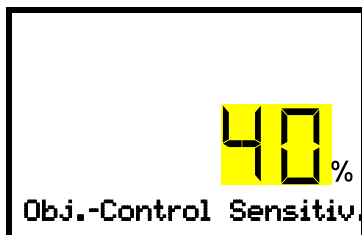

Setting the sensitivity of the object temperature control.  
The current setting flashes Use the **arrow buttons** to enter the desired sensitivity. Entry range: 1 % up to 100 %. Factory setting: 100%  
Confirm the entry with the **OK button**.

With the **arrow-down button** you can now change to setting the maximum deviation (chap. 22.6.3)

With the **Back button** you can go back to the "**Various**" submenu and, repeatedly pressing it, to **Normal display**.

## 22.6.3 Setting the maximum deviation

The purpose of setting the maximum deviation is to ensure that the interior of the chamber or the load does not become too hot due to the ambient interior temperature while the set-point temperature inside the load has not yet been reached. This function is particularly useful for applications with addition of heat, such as with lighting devices.

In this menu you can set the maximum permissible deviation between the object temperature and supply air temperature. This should be set as small as possible/necessary to avoid temperature fluctuations.

Required access level: "Admin".

Path: **Normal display** ▾ ▾ ▾ ▾ ▾ **Settings**  ▾ ▾ ▾ **Various**  ▾ ▾ ▾ ▾ ▾ **Max. correction temp.**

Press the **OK button** to enable the setting.



Setting the maximum permissible deviation.  
The current setting flashes Use the **arrow buttons** to enter the desired maximum deviation. Entry range: 0 °C up to 100 °C. Factory setting: 10 °C.  
Confirm the entry with the **OK button**.





With the **arrow-up button** you can go back to setting the sensitivity of the object temperature control (chap. 22.6.2).

With the **Back button** you can go back to the "**Various**" submenu and, repeatedly pressing it, to **Normal display**.

## 23. Cleaning and decontamination

Clean the chamber after each use in order to prevent potential corrosion damage by ingredients of the loading material.

Prior to renewed startup, allow the chamber to completely dry after all cleaning and decontamination measures.

  	 <b>DANGER</b>
	<p><b>Electrical hazard by water entering the chamber.</b>  <b>Deadly electric shock.</b></p> <ul style="list-style-type: none"> <li>Ø Do NOT spill water or cleaning agents over the inner and outer chamber surfaces.</li> <li>Ø Do NOT put ANY cleaning aids (cloth or brush) into slots or openings on the chamber.</li> <li>➤ Before cleaning, turn off the chamber at the On/Off switch (H) and disconnect the power plug. Let the chamber cool down to ambient temperature.</li> <li>➤ Completely dry the chamber before turning it on again.</li> </ul>

### 23.1 Cleaning

Disconnect the chamber from the power supply before cleaning. Pull the power plug.

	<p>The interior of the chamber must be kept clean. Thoroughly remove any residues of test material.</p>
---	---

Wipe the surfaces with a moistened towel. In addition, you can use the following cleaning agents:

<p>Exterior surfaces inner chamber racks door gaskets</p>	<p>Standard commercial cleaning detergents free from acid or halides. Alcohol-based solutions. We recommend using the neutral cleaning agent Art. No. 1002-0016.</p>
<p>Instrument panel</p>	<p>Standard commercial cleaning detergents free from acid or halides. We recommend using the neutral cleaning agent Art. No. 1002-0016.</p>
<p>Zinc coated hinge parts rear chamber wall</p>	<p>Standard commercial cleaning detergents free from acid or halides. Do NOT use a neutral cleaning agent on zinc coated surfaces.</p>

Do not use cleaning agents that may cause a hazard due to reaction with components of the device or the loading material. If there is doubt regarding the suitability of cleaning products, please contact BINDER service.

	<p>We recommend using the neutral cleaning agent Art. No. 1002-0016 for a thorough cleaning. Any corrosive damage that may arise following use of other cleaning agents is excluded from liability by BINDER GmbH. Any corrosive damage caused by a lack of cleaning, is excluded from liability by BINDER GmbH.</p>
---	--

	NOTICE
	<p><b>Danger of corrosion by using unsuitable cleaners.</b>  <b>Damage to the chamber.</b></p> <ul style="list-style-type: none"> <li>∅ Do NOT use acidic or chlorine cleaning detergents.</li> <li>∅ Do NOT use a neutral cleaning agent on other kind of surfaces e.g., the zinc coated hinge parts or the rear chamber wall.</li> </ul>

	<p>For surface protection, perform cleaning as quickly as possible.          After cleaning completely remove cleaning agents from the surfaces with a moistened towel.          Let the chamber dry.</p>
---	---







	<p>Soapsuds may contain chlorides and must therefore NOT be used for cleaning.</p>
---	--

	<p>With every cleaning method, always use adequate personal safety controls.</p>
---	--

Following cleaning, leave the chamber door open or remove the access port plugs.

	<p>The neutral cleaning agent may cause health problems in contact with skin and if ingested. Follow the operating instructions and safety hints labeled on the bottle of the neutral cleaning agent.</p>
--	---

Recommended precautions: To protect the eyes use sealed protective goggles. Wear gloves. Suitable protective gloves in full contact with media: butyl or nitrile rubber, penetration time >480 minutes.

 	 <b>CAUTION</b>
 	<p><b>Danger of chemical burns through contact with skin or ingestion of the neutral cleaning agent.</b>  <b>Skin and eye damage. Environmental damage.</b></p> <ul style="list-style-type: none"> <li>∅ Do not ingest the neutral cleaning agent. Keep it away from food and beverages.</li> <li>∅ Do NOT empty the neutral cleaning agent into drains.</li> <li>➤ Wear protective gloves and goggles.</li> <li>➤ Avoid skin contact with the neutral cleaning agent.</li> </ul>
	

## 23.2 Decontamination / chemical disinfection

The operator must ensure that proper decontamination is performed in case a contamination of the chamber by hazardous substances has occurred.

Disconnect the chamber from the power supply prior to chemical decontamination. Pull the power plug.

Do not use decontamination agents that may cause a hazard due to reaction with components of the device or the loading material. If there is doubt regarding the suitability of cleaning products, please contact BINDER service.

You can use the following disinfectants:

Inner chamber	Standard commercial surface disinfectants free from acid or halides. Alcohol-based solutions. We recommend using the disinfectant spray Art. No. 1002-0022.
---------------	---

	For chemical disinfection, we recommend using the disinfectant spray Art. No. 1002-0022. Any corrosive damage that may arise following use of other disinfectants is excluded from liability by BINDER GmbH.
---	---

	With every decontamination / disinfection method, always use adequate personal safety controls.
---	---

In case of contamination of the interior by biologically or chemically hazardous material, there are two possible procedures depending on the type of contamination and loading material:



1. Spray the inner chamber with an appropriate disinfectant.

Before start-up, the chamber must be absolutely dry and ventilated, as explosive gases may form during the decontamination process.

2. If necessary, have strongly contaminated inner chamber parts removed by an engineer for cleaning, or have them exchanged. Sterilize the inner chamber parts in a sterilizer or autoclave.

	In case of eye contact, the disinfectant spray may cause eye damage due to chemical burns. Follow the operating instructions and safety hints labeled on the bottle of the disinfectant spray.
--	--

Recommended precautions: To protect the eyes use sealed protective goggles.

	<div style="background-color: yellow; text-align: center; padding: 5px;"> <b>CAUTION</b></div> <p><b>Danger of chemical burns through eye contact with the disinfectant spray.</b></p> <p><b>Eye damage. Environmental damage</b></p> <ul style="list-style-type: none"> <li>⊘ Do NOT empty the disinfectant into drains.</li> <li>➤ Wear protective goggles.</li> </ul>
---	---

	After using the disinfectant spray, allow the chamber to dry thoroughly, and aerate it sufficiently.
---	--

### 23.3 Hot-air disinfection

See chap. 10.

## 24. Maintenance and service, troubleshooting, repair, testing

### 24.1 General information, personnel qualification

- **Maintenance**

See chap. 24.2

- **Simple troubleshooting**

Chap. 24.4 describes troubleshooting by operating personnel. It does not require technical intervention into the chamber, nor disassembly of chamber parts.

For personnel requirements please refer to chap. 1.1.

- **Detailed troubleshooting**

If errors cannot be identified with simple troubleshooting, further troubleshooting must be performed by BINDER Service or by BINDER qualified service partners or technicians, in accordance with the description in the Service Manual.

For personnel requirements please refer to the Service Manual.

- **Repair**

Repair of the chamber can be performed by BINDER Service or by BINDER qualified service partners or technicians, in accordance with the description in the Service Manual.



After maintenance, the chamber must be tested prior to resuming operation.

- **Electrical testing**

To prevent the risk of electrical shock from the electrical equipment of the chamber, an annual repeat inspection as well as a test prior to initial startup and prior to resuming operation after maintenance or repair, are required. This test must meet the requirements of the competent public authorities. We recommend testing under EN 50678/VDE 0701 and EN 50699/VDE 0702 in accordance with the details in the Service Manual.

For personnel requirements please refer to the Service Manual.

### 24.2 Maintenance intervals, service

 	 <b>DANGER</b>
<p><b>Electrical hazard during live maintenance work.</b>  <b>Deadly electric shock.</b></p> <ul style="list-style-type: none"> <li>Ø The chamber must NOT become wet during operation or maintenance works.</li> <li>Ø Do NOT remove the rear panel of the chamber.</li> <li>➤ Disconnect the chamber before conducting maintenance work. Turn off the On/Off switch (H) and pull the power plug.</li> <li>➤ Make sure that general maintenance work will be conducted by licensed electricians or experts authorized by BINDER.</li> <li>➤ Make sure that maintenance work at the refrigeration system will only be conducted by qualified personnel who underwent training in accordance with EN 13313:2010 (e.g. a refrigeration technician with certified expert knowledge acc. to Regulation (EC) n° 303/2008). Follow the national statutory regulations.</li> </ul>	

Ensure regular maintenance work is performed at least once a year and that the legal requirements are met regarding the qualifications of service personnel, scope of testing and documentation. All work on the refrigeration system (repairs, inspections) must be documented.



The warranty becomes void if maintenance work is conducted by non-authorized personnel.



Replace the door gasket only when cold. Otherwise, the door gasket may become damaged.

With an increased amount of dust in the ambient air, clean the condenser of the refrigeration machine (by suction) several times a year. It is located behind the cover for the machine room. You can remove this without tools. To do this, lift the cover upwards and pull it forwards. To reattach it, make sure that the retaining eyes at the top and bottom of the cover snap into the retaining screws.

We recommend taking out a maintenance agreement. Please consult BINDER Service:

BINDER telephone hotline:	+49 (0) 7462 2005 555
BINDER fax hotline:	+49 (0) 7462 2005 93555
BINDER service hotline USA:	+1 866 885 9794 or +1 631 224 4340 x3 (toll-free in the USA)
BINDER service hotline Asia Pacific:	+852 390 705 04 or +852 390 705 03
BINDER Internet website	<a href="http://www.binder-world.com">http://www.binder-world.com</a>
BINDER address	BINDER GmbH, post office box 102, 78502 Tuttlingen, Germany

International customers, please contact your local BINDER distributor.

### 24.3 Service Reminder

You can display the time until the service due in the controller. Keep the **OK button** pressed down for 5 seconds.



The remaining time in days until maintenance is due is shown in the text field of the controller display.  
Press the **OK button** to confirm the message.

After the recommended maintenance interval (one year of operation) a message appears on the controller.

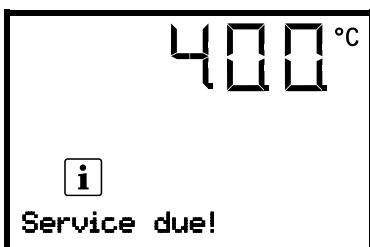

The message "Service due!" is shown in the text field of the controller display.  
Press the **OK button** to confirm the message.

After one week of operation, the message reappears.

### 24.4 Simple troubleshooting

Defects and shortcomings can compromise the operational safety of the chamber and can lead to risks and damage to equipment and persons. If there is a technical fault or shortcoming, take the chamber out of operation and inform BINDER Service. If you are not sure whether there is a technical fault, proceed according to the following list. If you cannot clearly identify an error or there is a technical fault, please contact BINDER Service.



Only qualified service personnel authorized by BINDER must perform repair.  
Repaired chambers must comply with the BINDER quality standards.



Fault description	Possible cause	Required measures
<b>General</b>		
Chamber without function.	No power supply.	Check connection to power supply. Check whether the chamber is turned on at the On/Off switch (H).
	Wrong voltage.	Check power supply for correct voltage (chap. 4.5).
	Chamber fuse has responded.	Check chamber fuse and replace it if appropriate. If it responds again, contact BINDER service.
	Controller defective.	Contact BINDER service.
	Nominal temperature exceeded by 10° due to chamber failure. Over temperature protective device (class 1) responds.	
<b>Heating</b>		
Set-point temperature is not reached after specified time.	Chamber door not properly closed.	Completely close chamber door.
	Defective door gasket.	Replace door gasket,
	Controller not well adjusted.	Calibrate and adjust controller.
Chamber heating permanently, set-point not maintained.	Controller defective.	Contact BINDER service.
	Pt 100 sensor defective.	
	Controller not well adjusted.	Calibrate and adjust controller
Chamber doesn't heat up. Heating icon is displayed.	Heating element defective.	Contact BINDER service.
	Semiconductor relay defective.	
Chamber doesn't heat up. No heating icon in the display. Controller display working.	Timer run off.	Re-program the timer or turn it off.
	Defective semiconductor relay.	Contact BINDER service.
	Defective controller.	
Chamber doesn't heat up when turned on. Safety controller responds.. Alarm message "Safety controller(high)" is displayed.	Inner chamber temperature has reached the safety controller set-point. Limit temperature for over-temperature protection set too low.	Acknowledge the alarm on the controller. Check temperature set-point and safety controller setpoint. If appropriate, select suitable safety controller setpoint (chap. 12.2).
	Safety controller defective.	Contact BINDER service.
Chamber doesn't cool down when turned on. Safety controller responds. Alarm message "Safety controller(low)" is displayed.	Inner chamber temperature has reached the safety controller trigger value. Limit temperature for undertemperature protection set too high.	Acknowledge the alarm on the controller. Check temperature set-point and safety controller trigger value. If appropriate, select suitable trigger value (chap. 12.3).
	Safety controller defective.	Contact BINDER service.
Deviations from the indicated heating-up times.	Chamber fully loaded.	Load the chamber less or consider longer heating-up times.

Fault description	Possible cause	Required measures
<b>Refrigerating performance</b>		
Set-point temperature is not reached after specified time.	Chamber door not properly closed.	Completely close chamber door.
	Defective door gasket.	Replace door gasket,
	Controller not well adjusted.	Calibrate and adjust controller.
Low or no refrigerating performance.	Ambient temperature > 25 °C / 77 °F (chap.3.4).	Select cooler place of installation.
	Compressor not turned on.	Contact BINDER service.
	Electro-valves defective.	
	No or not enough refrigerant.	
	Too much external heat load.	Reduce heat load.
<b>Controller</b>		
No chamber function (dark display).	On/Off switch (H) turned off.	Turn on the On/Off switch (H).
Menu functions not available.	Menu functions not available with current authorization level.	Log in with the required higher authorization.
No access to controller	Password incorrect.	Contact BINDER service.
Acknowledging the alarm does not cancel the alarm state.	Cause of alarm persists.	Remove cause of alarm. If the alarm state continues, contact BINDER service.
Alarm message: - - - - or <-<-< or >->->	Sensor rupture between sensor and controller or Pt 100 sensor defective.	Contact BINDER service.
	Short-circuit.	
Alarm message "Safety controller sensor" is displayed.	Safety controller temperature sensor defective.	Contact BINDER service.
Actual temperature value display shows " - - - - "	Regular temperature sensor defective..	

## 24.5 Sending the chamber back to BINDER GmbH

If you return a BINDER product to us for repair or any other reason, we will only accept the product upon presentation of an **authorization number** (RMA number) that has previously been issued to you. An authorization number will be issued after receiving your complaint either in writing or by telephone **prior** to your sending the BINDER product back to us. The authorization number will be issued following receipt of the information below:

- BINDER product type and serial number
- Date of purchase
- Name and address of the dealer from which you bought the BINDER product
- Exact description of the defect or fault
- Complete address, contact person and availability of that person
- Exact location of the BINDER product in your facility
- A contamination clearance certificate (chap. 28) must be faxed in advance

The authorization number must be applied to the packaging in such a way that it can be easily recognized or be recorded clearly in the delivery documents.



For security reasons we cannot accept a chamber delivery if it does not carry an authorization number.

**Return address:** BINDER GmbH      Gänsäcker 16  
Abteilung Service      78502 Tuttlingen  
Germany

## 25. Disposal

### 25.1 Disposal of the transport packing

Packing element	Material	Disposal
Straps to fix packing on pallet	Plastic	Plastic recycling
Wooden transport box (option) with metal screws	Non-wood (compressed match-wood, IPPC standard)	Wood recycling
	Metal	Metal recycling
Pallet with foamed plastic stuffing	Solid wood (IPPC standard)	Wood recycling
	PE foam	Plastic recycling
Transport box with metal clamps	Cardboard	Paper recycling
	Metal	Metal recycling
Top cover	Cardboard	Paper recycling
Edge protection	Styropor® or PE foam	Plastic recycling
Protection of doors and racks	PE foam	Plastic recycling
Bag for operating manual	PE foil	Plastic recycling
Insulating air cushion foil (packing of optional accessories)	PE foil	Plastic recycling

If recycling is not possible, all packing parts can also be disposed of with normal waste.

### 25.2 Decommissioning

- Turn off the chamber at the On/Off switch (H) and disconnect it from the power supply (pull the power plug).
- Temporal decommissioning: See indications for appropriate storage, chap. 3.3.
- Final decommissioning: Dispose of the chamber as described in chap. 25.3 to 25.5.

### 25.3 Disposal of the chamber in the Federal Republic of Germany

According to Annex I of Directive 2012/19/EU of the European Parliament and of the Council on waste electrical and electronic equipment (WEEE), BINDER devices are classified as “monitoring and control instruments” (category 9) only intended for professional use”. They must not be disposed of at public collecting points.

The chambers bear the symbol for the marking of electrical and electronic equipment manufactured / placed on the market in the EU after 13 August 2005 and be disposed of in separate collection according to Directive 2012/19/EU on waste electrical and electronic equipment (WEEE) and German national law for electrical and electronic equipment (Elektro- und Elektronikgerätegesetz, ElektroG). WEEE marking: crossed-out wheeled bin. A significant part of the materials must be recycled in order to protect the environment.

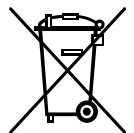

At the end of the device’s service life, have the chamber disposed of according to the German national law for electrical and electronic equipment (Elektro- und Elektronikgerätegesetz, ElektroG from 20 October 2015, BGBl. I p. 1739) or contact BINDER service who will organize taking back and disposal of the chamber according to the German national law for electrical and electronic equipment (Elektro- und Elektronikgerätegesetz, ElektroG from 20 October 2015, BGBl. I p. 1739).

	NOTICE
	<p><b>Danger of violation against existing law if not disposed of properly.</b></p> <p><b>Failure to comply with applicable law.</b></p> <ul style="list-style-type: none"> <li>∅ Do NOT dispose of BINDER devices at public collecting points.</li> <li>➤ Have the device disposed of professionally at a recycling company which is certified according to the German national law for electrical and electronic equipment (Elektro- und Elektronikgerätegesetz, ElektroG from 20 October 2015, BGBl. I p. 1739).</li> <li style="text-align: center;">or</li> <li>➤ Instruct BINDER Service to dispose of the device. The general terms of payment and delivery of BINDER GmbH apply, which were valid at the time of purchasing the chamber.</li> </ul>

Certified companies disassemble waste (used) BINDER equipment in primary substances for recycling according to Directive 2012/19/EU. The devices must be free from toxic, infectious or radioactive substances in order to eliminate any health hazards to the employees of the recycling companies.

	<p>Prior to handing the chamber over to a recycling company, it is the user's responsibility that it is free from toxic, infectious or radioactive substances.</p> <ul style="list-style-type: none"> <li>• Prior to disposal, clean all introduced or residual toxic substances from the chamber.</li> <li>• Prior to disposal, disinfect the chamber from all sources of infection. Be aware that sources of infection may also be located outside the inner chamber.</li> <li>• If you cannot safely remove all toxic substances and sources of infection from the chamber, dispose of it as special waste according to national law.</li> <li>• Fill out the contamination clearance certificate (chap. 28) and enclose it with the chamber.</li> </ul>
---	---

	! WARNING
	<p><b>Danger of intoxication and infection through contamination of the chamber with toxic, infectious or radioactive substances.</b></p> <p><b>Damages to health.</b></p> <ul style="list-style-type: none"> <li>∅ NEVER take a chamber contaminated with toxic substances or sources of infection for recycling according to Directive 2012/19/EU.</li> <li>➤ Prior to disposal, remove all toxic substances and sources of infection from the chamber.</li> <li>➤ A chamber from which all toxic substances or sources of infection cannot be safely removed must be considered as "special" waste according to national law. Dispose of it accordingly.</li> </ul>

The refrigerant used R600A (isobutane, GWP 3) is flammable at ambient pressure. A suction is not required. Ensure the compliance with the applicable legal requirements regarding qualification of staff, and documentation.

## 25.4 Disposal of the chamber in the member states of the EU except for the Federal Republic of Germany

According to Annex I of Directive 2012/19/EU of the European Parliament and of the Council on waste electrical and electronic equipment (WEEE), BINDER devices are classified as "monitoring and control instruments" (category 9) only intended for professional use". They must not be disposed of at public collecting points.

The chambers bear the symbol for the marking of electrical and electronic equipment manufactured / placed on the market in the EU after 13 August 2005 and be disposed of in separate collection according to the Directive 2012/19/EU on waste electrical and electronic equipment (WEEE). WEEE marking: crossed-out wheeled bin.

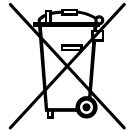



At the end of the device's service life, notify the distributor who sold you the device, who will take back and dispose of the chamber according to the Directive 2012/19/EU on waste electrical and electronic equipment (WEEE).

<b>NOTICE</b>	
	<p><b>Danger of violation against existing law if not disposed of properly.</b>  <b>Failure to comply with applicable law.</b></p> <ul style="list-style-type: none"> <li>⊘ Do NOT dispose of BINDER devices at public collecting points.</li> <li>➤ Have the device disposed of professionally at a recycling company that is certified according to conversion of the Directive 2012/19/EU into national law.</li> <li style="text-align: center;"><i>or</i></li> <li>➤ Instruct the distributor who sold you the device to dispose of it. The agreements apply that were agreed with the distributor when purchasing the chamber (e.g. his general terms of payment and delivery).</li> <li>➤ If your distributor is not able to take back and dispose of the chamber, please contact BINDER service.</li> </ul>



Certified companies disassemble waste (used) BINDER equipment in primary substances for recycling according to Directive 2012/19/EU. The devices must be free from toxic, infectious or radioactive substances in order to eliminate any health hazards to the employees of the recycling companies.

	<p>Prior to handing the chamber over to a recycling company, it is the user's responsibility that it is free from toxic, infectious or radioactive substances.</p> <ul style="list-style-type: none"> <li>• Prior to disposal, clean all introduced or residual toxic substances from the chamber.</li> <li>• Prior to disposal, disinfect the chamber from all sources of infection. Be aware that sources of infection may also be located outside the inner chamber.</li> <li>• If you cannot safely remove all sources of infection and toxic substances from the chamber, dispose of it as special waste according to national law.</li> <li>• Fill out the contamination clearance certificate (chap. 28) and enclose it with the chamber.</li> </ul>
---	---

 <b>WARNING</b>	
 	<p><b>Danger of intoxication and infection through contamination of the chamber with toxic, infectious or radioactive substances.</b>  <b>Damages to health.</b></p> <ul style="list-style-type: none"> <li>⊘ NEVER take a chamber contaminated with toxic substances or sources of infection for recycling according to Directive 2012/19/EU.</li> <li>➤ Prior to disposal, remove all toxic substances and sources of infection from the chamber.</li> <li>➤ A chamber from which all toxic substances or sources of infection cannot be safely removed must be considered as "special" waste according to national law. Dispose of it accordingly.</li> </ul>

The refrigerant used R600A (isobutane, GWP 3) is inflammable at ambient pressure. A suction is not required. Ensure the compliance with the applicable legal requirements regarding qualification of staff, and documentation.

## 25.5 Disposal of the chamber in non-member states of the EU

 	<p style="text-align: center;"><b>NOTICE</b></p> <p><b>Danger of violation against existing law if not disposed of properly.</b>  <b>Failure to comply with applicable law. Alteration of the environment.</b></p> <ul style="list-style-type: none"> <li>➤ For final decommissioning and disposal of the chamber, please contact BINDER service.</li> <li>➤ Follow the statutory regulations for appropriate, environmentally friendly disposal.</li> </ul>
--	--

The refrigerant used R600A (isobutane, GWP 3) is inflammable at ambient pressure. A suction is not required. Ensure the compliance with the applicable legal requirements regarding qualification of staff, and documentation.

## 26. Technical description

### 26.1 Factory calibration and adjustment

The chambers were calibrated and adjusted in the factory. Calibration and adjustment were performed using standardized test instructions, according to the QM DIN EN ISO 9001 system applied by BINDER (certified since December 1996 by TÜV CERT). All test equipment used is subject to the administration of measurement and test equipment that is also a constituent part of the BINDER QM DIN EN ISO 9001 systems. They are controlled and calibrated to a DKD-Standard at regular intervals.

	<p>Repeated calibrations are recommended in periods of 12 months.</p>
---	---

### 26.2 Over current protection

The chambers are equipped with an internal fuse not accessible from outside. If this fuse is blown, please contact an electronic engineer or BINDER service.

### 26.3 Definition of usable volume

The usable volume illustrated below is calculated as follows:

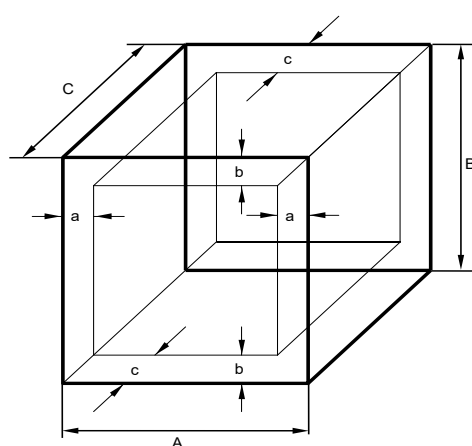

A, B, C = internal dimensions (W, H, D)

a, b, c = distance to wall

$$a = 0.1 \cdot A$$

$$b = 0.1 \cdot B$$

$$c = 0.1 \cdot C$$

$$V_{\text{USE}} = (A - 2 \cdot a) \cdot (B - 2 \cdot b) \cdot (C - 2 \cdot c)$$

Figure 15: Determination of the usable volume

The technical data refers to the defined usable volume.

	<p>Do NOT place samples outside this usable volume.</p> <p>Do NOT load this volume by more than half to enable sufficient airflow inside the chamber.</p> <p>Do NOT divide the usable volume into separate parts with large area samples.</p> <p>Do NOT place samples too close to each other in order to permit circulation between them and thus obtain a homogenous distribution of temperature.</p>
---	---

## 26.4 KB / KB-UL Technical Data

Chamber size		65	130	260	470	720	1060
<b>Exterior dimensions</b>							
Width, gross (incl. access port)	mm / inch	684 / 26.93	935 / 36.81	981 / 38.62	981 / 38.62	1363 / 53.66	1363 / 53.66
Height, gross (incl. feet/castors)	mm / inch	905 / 35.63	1005 / 39.57	1392 / 54.80	1949 / 76.73	1949 / 76.73	1949 / 76.73
Depth, net	mm / inch	711 / 27.99	711 / 27.99	900 / 35.43	900 / 35.43	900 / 35.43	1175 / 46.26
Depth, gross (including door handle, controller, connection and 30 mm for cable)	mm / inch	765 / 30.12	765 / 30.12	950 / 37.40	950 / 37.40	950 / 37.40	1225 / 48.23
Wall clearance, rear (minimum) (spacer)	mm / inch	100 / 3.94	100 / 3.94	100 / 3.94	100 / 3.94	100 / 3.94	100 / 3.94
Wall clearance, right (minimum)	mm / inch	100 / 3.94	100 / 3.94	180 / 7.09	180 / 7.09	180 / 7.09	180 / 7.09
Wall clearance, left (minimum)	mm / inch	100 / 3.94	100 / 3.94	100 / 3.94	100 / 3.94	180 / 7.09	180 / 7.09
<b>Doors</b>							
Quantity of doors		1	1	1	1	2	2
Quantity of glass doors		1	1	1	1	2	2
<b>Interior dimensions</b>							
Width	mm / inch	400 / 15.75	650 / 25.59	650 / 25.59	650 / 25.59	1000 / 39.37	1000 / 39.37
Height	mm / inch	400 / 15.75	500 / 19.68	700 / 27.56	1250 / 49.21	1250 / 49.21	1250 / 49.21
Depth	mm / inch	400 / 15.75	400 / 15.75	575 / 22.64	575 / 22.64	575 / 22.64	850 / 33.46
Interior volume	l / cu.ft.	64 / 2.26	130 / 4.59	262 / 9.25	467 / 16.49	719 / 25.39	1063 / 37.54
Steam space volume	l / cu.ft.	102 / 3.60	187 / 6.60	360 / 12.71	629 / 22.21	927 / 32.74	1316 / 46.47
<b>Racks</b>							
Quantity of racks (regular)		2	2	2	2	2	2
Quantity of racks (max.)		4	6	9	16	16	16
Maximum load per standard rack	kg / lbs.	25 / 55	25 / 55	30 / 66	40 / 88	40 / 88	40 / 88
Maximum load per reinforced rack (option)	kg / lbs.	50 / 110	50 / 110	60 / 132	80 / 176	80 / 176	80 / 176
Permissible total load	kg / lbs.	50 / 110	50 / 110	90 / 198	90 / 198	100 / 220	100 / 220
<b>Weight</b>							
Weight (empty)	kg / lbs.	95 / 209	124 / 273	174 / 384	212 / 467	285 / 628	315 / 694



Chamber size			65	130	260	470	720	1060
<b>Temperature performance data</b>								
Temperature range	from	°C / °F	0 / 32	0 / 32	0 / 32	0 / 32	0 / 32	0 / 32
	up to	°C / °F	70 / 158	70 / 158	70 / 158	70 / 158	70 / 158	70 / 158
Hot-air disinfection		°C / °F	100 / 212	100 / 212	100 / 212	100 / 212	100 / 212	100 / 212
Temperature fluctuation	at 5 °C / 41 °F	+/- K	0,7	0,8	0,9	1,1	0,6	0,7
	at 25 °C / 77 °F	+/- K	0,2	0,2	0,2	0,2	0,2	0,2
	at 37 °C / 98.6 °F	+/- K	0,2	0,2	0,2	0,2	0,2	0,2
Temperature uniformity (variation)	at 5 °C / 41 °F	+/- K	0,2	0,1	0,1	0,1	0,1	0,1
	at 25 °C / 77 °F	+/- K	0,2	0,1	0,1	0,1	0,1	0,1
	at 37 °C / 98.6 °F	+/- K	0,2	0,1	0,1	0,1	0,1	0,1
Recovery time after one door was open for 30 s	at 5 °C / 41 °F	minutes	8	6	6	9	10	14
	at 25 °C / 77 °F	minutes	3	3	3	3	3	3
	at 37 °C / 98.6 °F	minutes	1	1	1	1	1	1
Max. heat compensation	at 37 °C / 98.6 °F	W	160	270	410	530	640	640
<b>Electrical data KB / KB-UL</b>								
System of protection acc. to EN 60529	IP		20	20	20	20	20	20
Current type			1N~	1N~	1N~	1N~	1N~	1N~
Nominal power	kW		0,9	1,2	1,3	1,3	1,5	1,5
Installation category acc. to IEC 61010-1			II	II	II	II	II	II
Pollution degree acc. to IEC 61010-1			2	2	2	2	2	2
Over-current release category B, 2 poles	Amp		16 internal	16 internal	16 internal	16 internal	16 internal	16 internal
<b>Electrical data KB</b>								
Nominal voltage (+/-10%) at 50 Hz power frequency	V		220-240	220-240	220-240	220-240	220-240	220-240
Nominal voltage (+/-10%) at 60 Hz power frequency	V		220-240	220-240	220-240	220-240	220-240	220-240
Power plug			CEE 7/7 grounded plug					
<b>Electrical data KB-UL</b>								
Nominal voltage (+/-10%) at 50 Hz power frequency	V		120	120	120	120	120	120
Nominal voltage (+/-10%) at 60 Hz power frequency	V		120	120	120	120	120	120
Power plug	NEMA		5-20P	5-20P	5-20P	5-20P	5-20P	5-20P
<b>Environment-specific data</b>								
Noise level (mean value)	at 25 °C / 77 °F, equilibrated	dB (A)	44	47	50	51	51	52
Energy consumption for 220-240 V / 50Hz	at 4 °C / 39.2 °F	Wh/h	≤ 135	≤ 245	≤ 250	≤ 275	≤ 375	≤ 380
	at 25 °C / 77 °F	Wh/h	≤ 80	≤ 115	≤ 130	≤ 135	≤ 235	≤ 240
	at 37 °C / 98.6 °F	Wh/h	≤ 90	≤ 125	≤ 140	≤ 140	≤ 255	≤ 260
Energy consumption for 120 V / 60Hz	at 4 °C / 39.2 °F	Wh/h	≤ 150	≤ 235	≤ 285	≤ 305	≤ 390	≤ 430
	at 25 °C / 77 °F	Wh/h	≤ 95	≤ 150	≤ 155	≤ 170	≤ 240	≤ 270
	at 37 °C / 98.6 °F	Wh/h	≤ 100	≤ 155	≤ 165	≤ 165	≤ 280	≤ 300
Filling weight of refrigerant R600a (isobutane, GWP 3)	kg / lbs.		0,06 / 0,132	0,06 / 0,132	0,095 / 0,209	0,095 / 0,209	0,095 / 0,209	0,095 / 0,209



All technical data is specified for unloaded chambers with standard equipment at an ambient temperature of +22 °C +/- 3°C / 71.6 °F +/- 5.4 °F and a power supply voltage fluctuation of +/-10%. Specification of the sound pressure level +/- 1 dB(A). Technical data is determined in accordance to BINDER Factory Standard Part 2:2015 and DIN 12880:2007.

**All indications are average values, typical for chambers produced in series. We reserve the right to change technical specifications at any time.**



If the chamber is fully loaded, the specified heating up and cooling down times may vary according to the load.

## 26.5 Equipment and options (extract)



To operate the chamber, use only original BINDER accessories or accessories / components from third-party suppliers authorized by BINDER. The user is responsible for any risk arising from using unauthorized accessories.

Regular equipment
RD4 microprocessor controller for temperature
Ethernet interface for computer communication
USB interface
Safety controller class 2 or 3.3 (adjustable) acc. to DIN 12880:2007
Inner glass door with gasket
Cooling system with environmentally friendly, non-climate-damaging hydrocarbon refrigerant
From size 260 on: 4 castors (2 lockable)
2 racks, stainless steel
Access port 30 mm with silicone plug (chamber sizes 65/130), elongated access port (from size 260 on)

Options
Access ports 30 mm or 50 mm or 100 mm top and/or right with silicone plug
Analog outputs for temperature 4-20mA with socket, plug included
Zero-voltage relay alarm outputs for collective alarm with socket, plug included
Object temperature display/control with flexible Pt 100 temperature sensor
Lockable door
Lockable door with electromechanical locking
LED interior lighting

## 26.6 Accessories and spare parts (extract)



BINDER GmbH is responsible for the safety features of the chamber only, provided skilled electricians or qualified personnel authorized by BINDER perform all maintenance and repair, and if components relating to chamber safety are replaced in the event of failure with original spare parts. The user is responsible for any risks arising from using unauthorized accessories/components.

Chamber size	65	130	260	470	720	1060
<b>Description</b>	<b>Art. no.</b>					
Rack, stainless steel with telescopic rail	---	---	8012-2384	8012-2384	8012-2385	8012-2386
Rack, stainless steel with U rail	8012-2388	8012-2389	8012-2390	8012-2390	8012-2392	8012-2392
Perforated rack, stainless steel	8012-2405	8012-2406	8012-2407	8012-2407	8012-2408	8012-2409
Reinforced rack with U rail	---	8012-2412	8012-2413	8012-2413	8012-2414	8012-2415

Chamber size	65	130	260	470	720	1060
Description	Art. no.					
Chamber gaskets, complete set	8500-0356	8500-0357	8500-0358	8500-0359	8500-0360	8500-0360
Base with castors	9051-0055	9051-0045	---	---	---	---
Flat stacking adapter	9051-0056	9051-0048	---	---	---	---

Description	Art. no.
Plug for silicon access port d30	6016-0035
Plug for elongated access port	6016-0065
Neutral cleaning agent, 1 kg	1002-0016
Flexible anti-tilt protection, set, for chambers sizes 65/130/470	8009-0828

For information on components not listed here, please contact BINDER Service.

Validation service	Art. no.
Qualification folder IQ-OQ (printed version)	7007-0001
Qualification folder IQ-OQ (digital version)	7057-0001
Qualification folder IQ-OQ-PQ (printed version)	7007-0005
Qualification folder IQ-OQ-PQ (digital version)	7057-0005
Execution of IQ-OQ	DL410200
Execution of IQ-OQ-PQ	DL440500

Calibration service	Art. no.
Calibration of temperature including certificate (1 measuring point)	DL300101
Spatial temperature measurement including certificate (9 measuring points)	DL300109
Spatial temperature measurement including certificate (18 measuring points)	DL300118
Spatial temperature measurement including certificate (27 measuring points)	DL300127

## 26.7 Dimensions

Dimensions size 65:

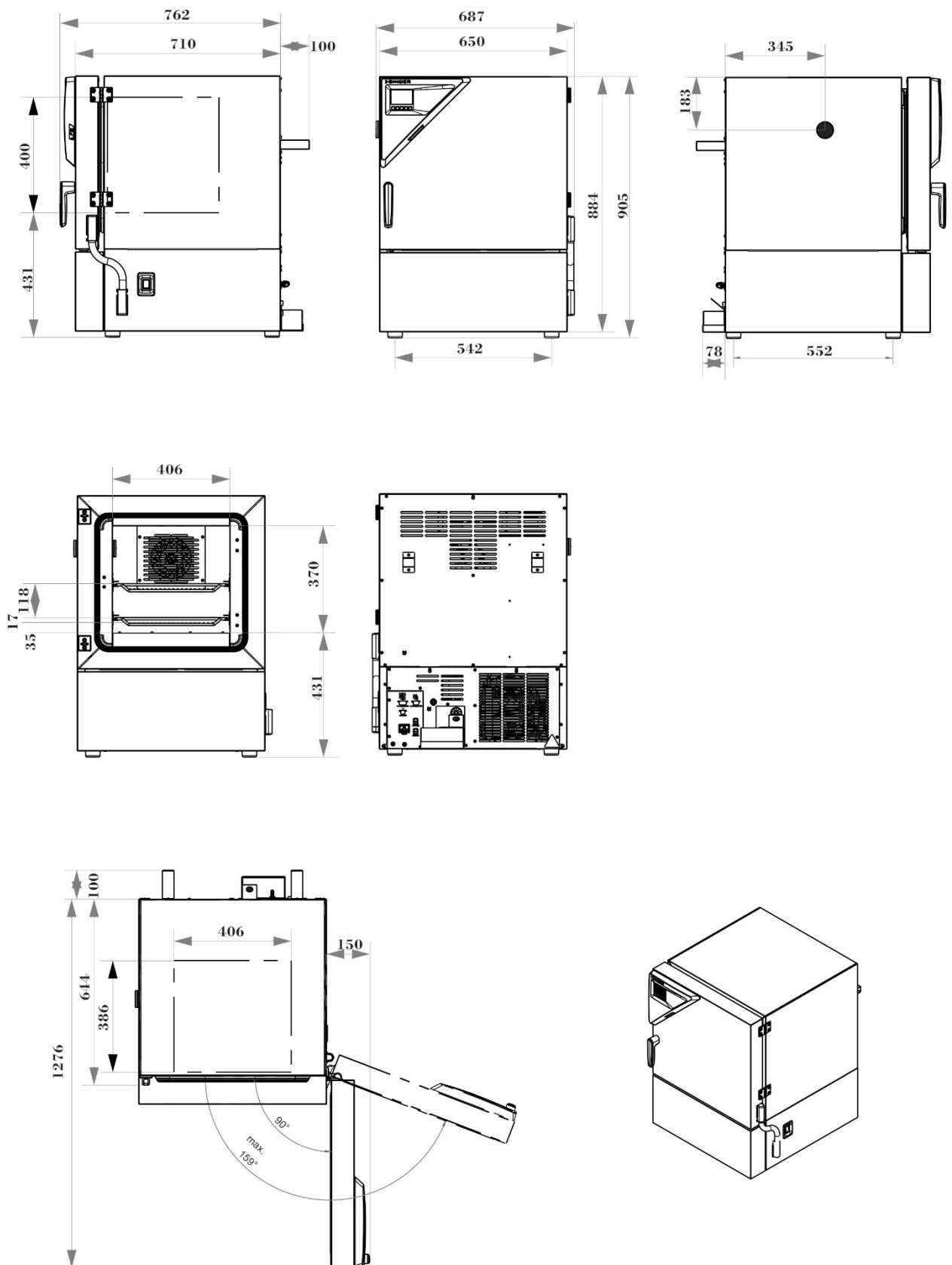

[mm]

Dimensions size 130:

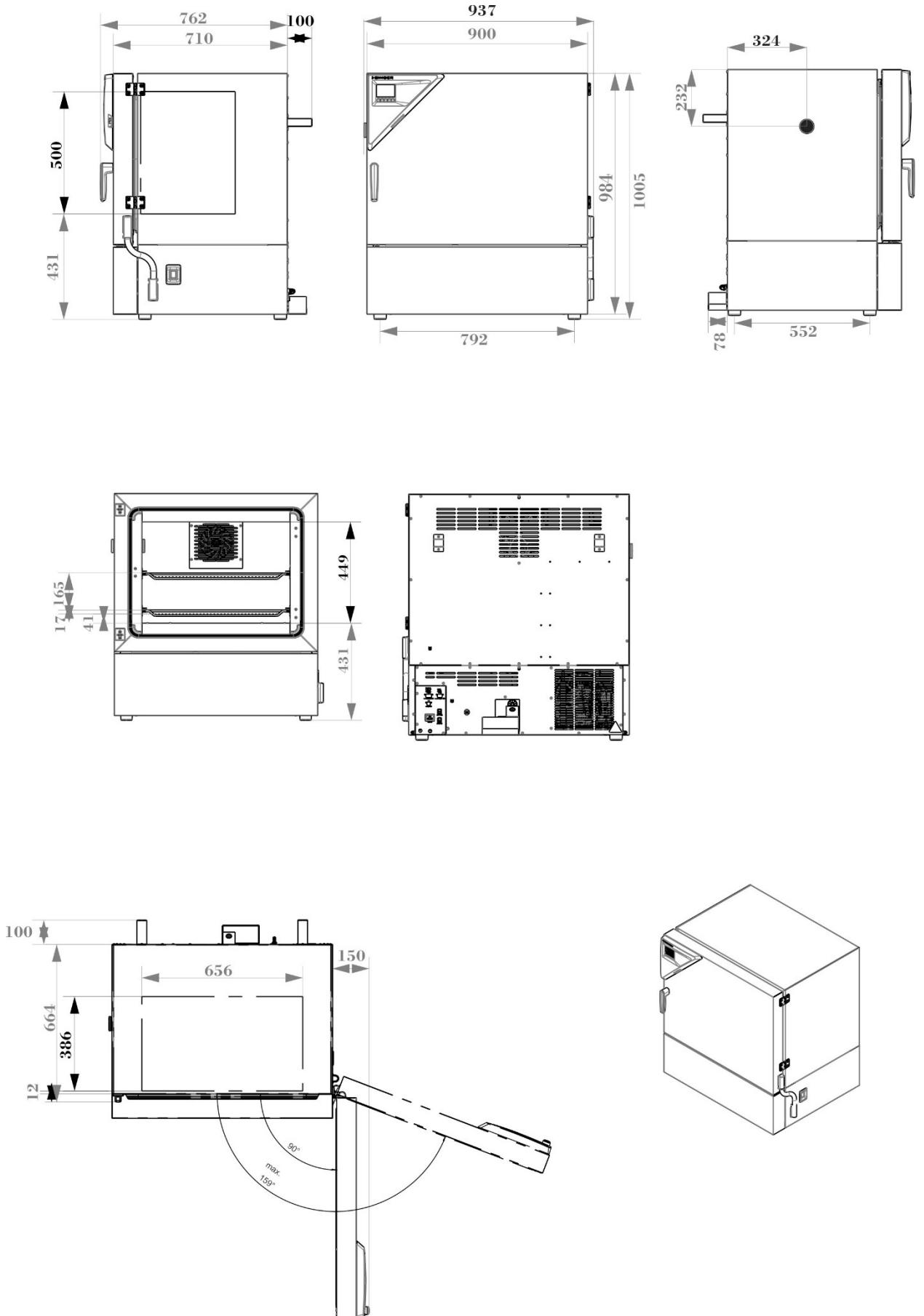

[mm]

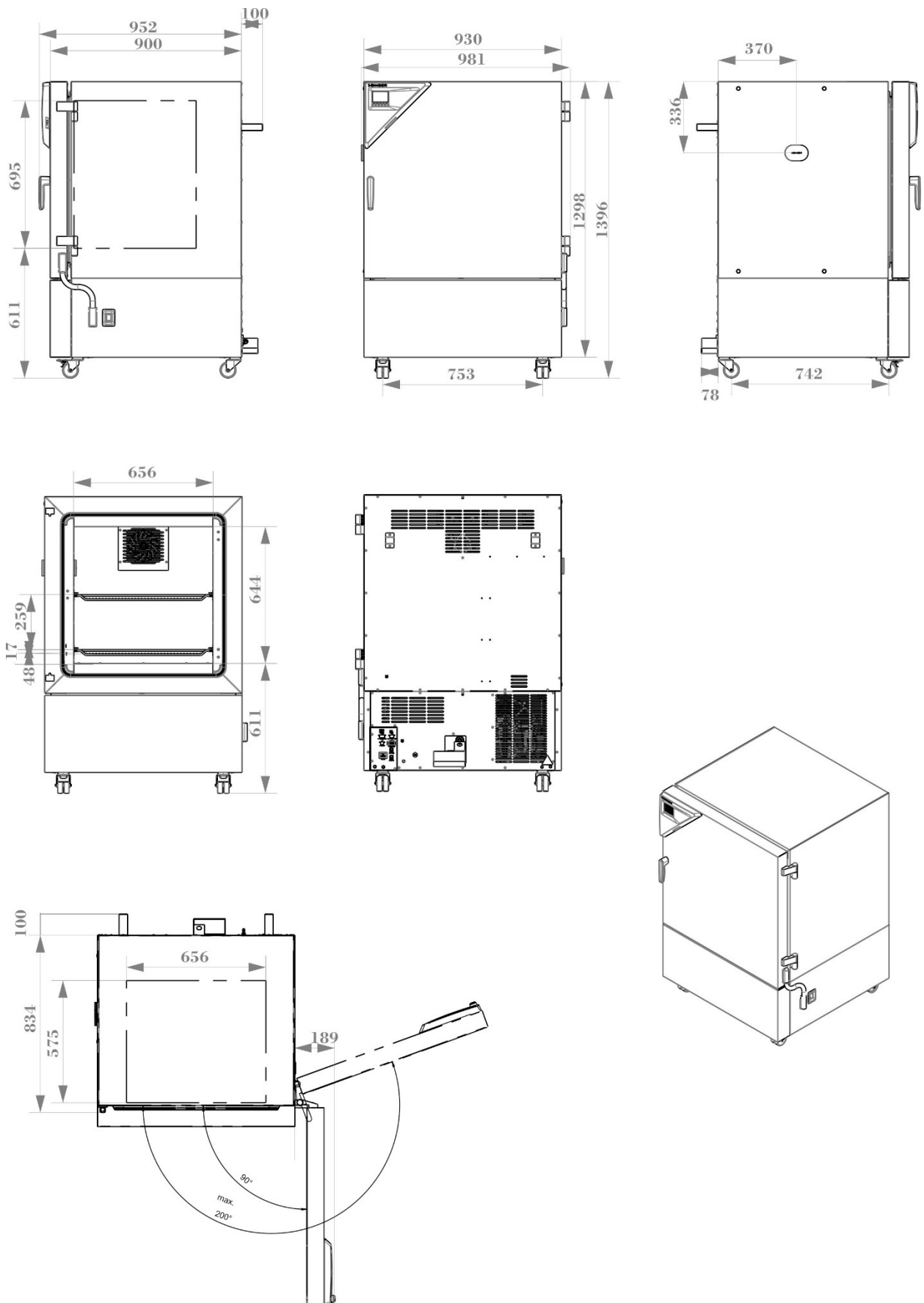
**Dimensions size 260:**

[mm]

Dimensions size 470:

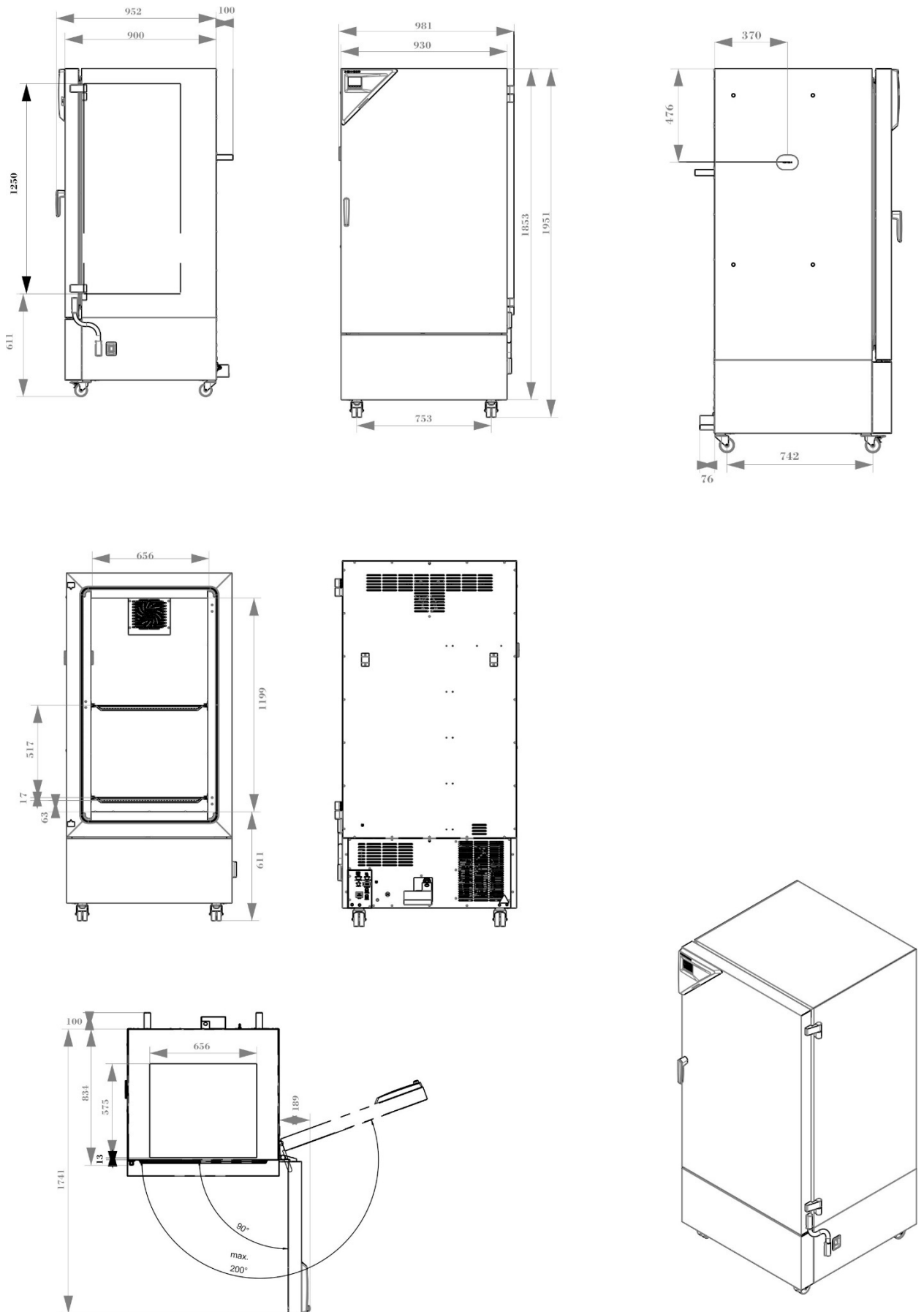

[mm]

Dimensions size 720:

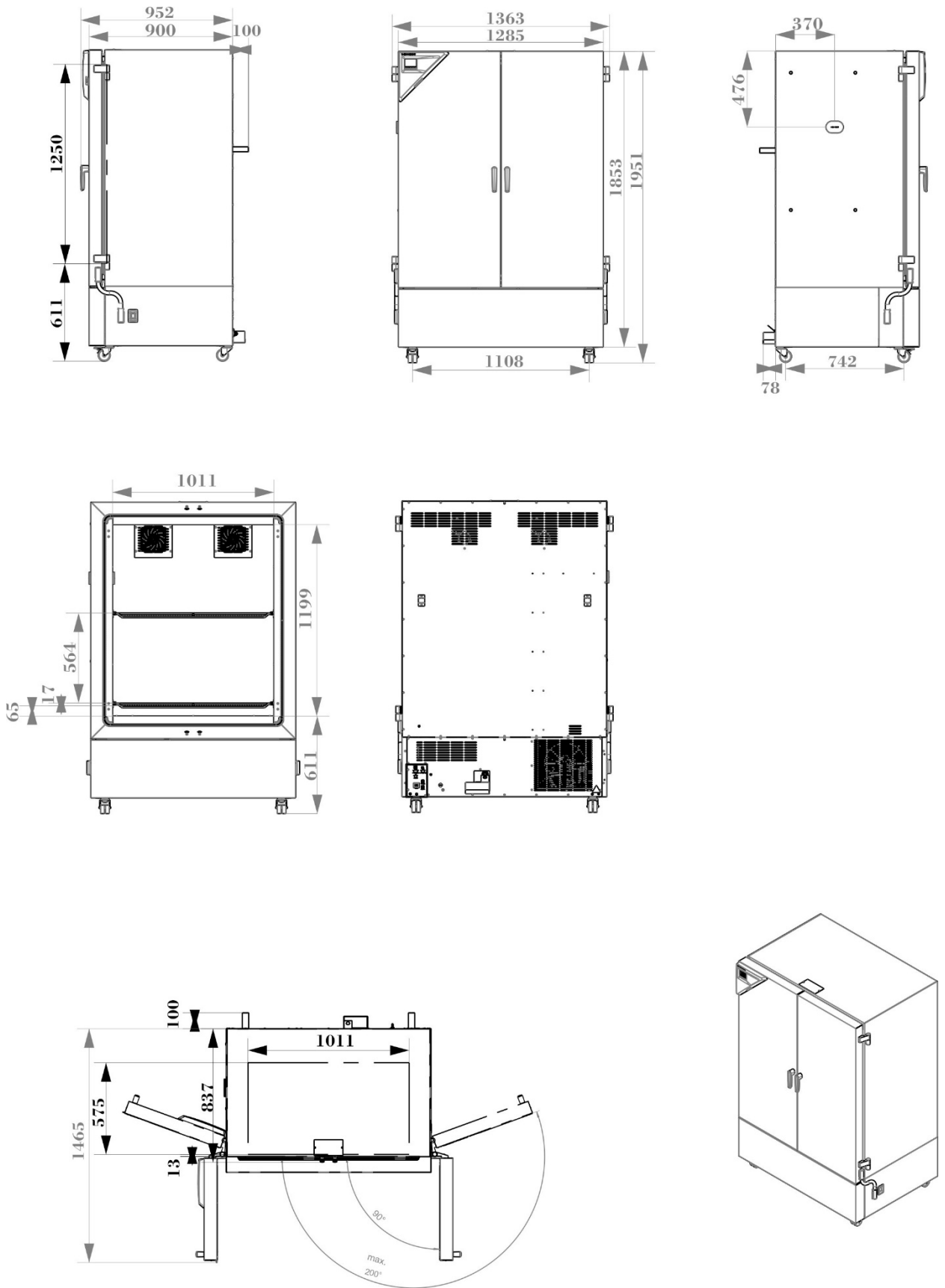

[mm]

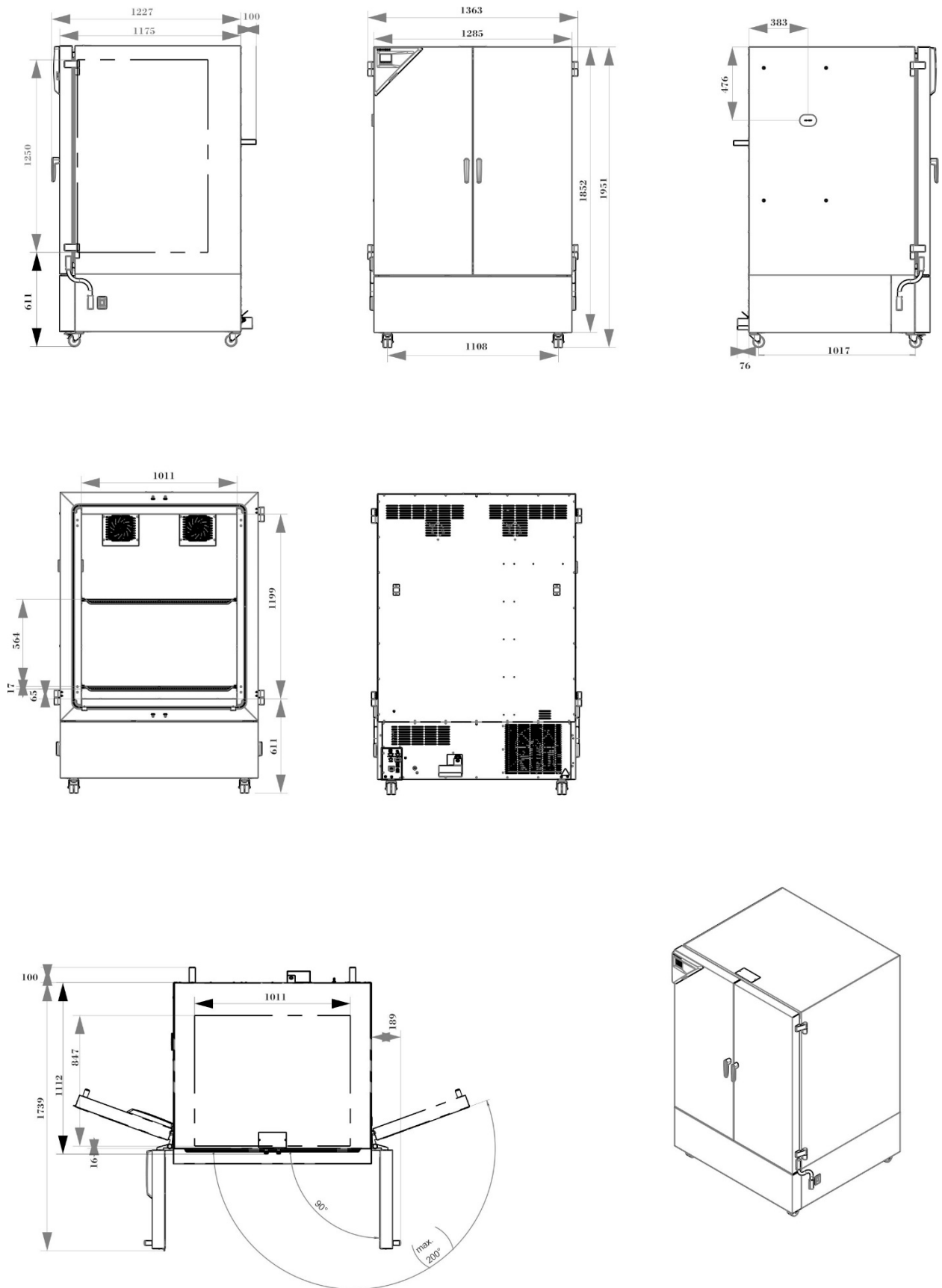
**Dimensions size 1060:**

[mm]



## 27. Certificates and declarations of conformity

### 27.1 EU Declaration of Conformity



**CE** EU-Konformitätserklärung / EU Declaration of Conformity / Déclaration de conformité UE / Declaración de conformidad UE / Dichiarazione di conformità UE / Декларация соответствия EU

Hersteller / Manufacturer / Fabricant / Fabricante / Fabbricante / Производитель	BINDER GmbH
Anschrift / Address / Adresse / Dirección / Indirizzo / Адрес	Im Mittleren Ösch 5, 78532 Tuttlingen, Germany
Produkt / Product / Produit / Producto / Prodotto / Продукт	Kühlinkubatoren mit Kompressortechnologie Cooling incubators with compressor technology Incubateurs réfrigérés avec technologie de compresseur Incubadoras refrigeradas con tecnología de compresores Incubatori refrigerati con tecnologia a compressore Инкубаторы с охлаждением с компрессорной технологией
Typenbezeichnung / Type / Type / Tipo / Tipo / Тип	KB 65, KB 130, KB 260, KB 470, KB 720, KB 1060 (E7) KB 65-UL, KB 130-UL, KB 260-UL, KB 470-UL, KB 720-UL, KB 1060-UL (E7)
Art. No. / Art. no. / Réf. / Art. N° / Art. n. / № арт.	9020-0471, 9120-0471, 9020-0491, 9120-0491 9020-0472, 9120-0472, 9020-0500, 9120-0500 9020-0473, 9120-0473, 9020-0501, 9120-0501 9020-0474, 9120-0474, 9020-0502, 9120-0502 9020-0475, 9120-0475, 9020-0503, 9120-0503 9020-0476, 9120-0476, 9020-0504, 9120-0504

Die oben beschriebenen Maschinen sind konform mit folgenden EG/EU-Richtlinien (gemäß Veröffentlichung im Amtsblatt der europäischen Kommission):

The machines described above are in conformity with the following EC/EU Directives (as published in the Official Journal of the European Union):

Les machines décrites ci-dessus sont conformes aux directives CE/UE suivantes (selon leur publication dans le Journal officiel de l'Union européenne):

La máquina descrita arriba cumple con las siguientes directivas de la CE/UE (publicados en el Diario oficial de la Unión Europea):

Le macchine sopra descritte sono conforme alle seguenti direttive CE/UE (secondo la pubblicazione nella Gazzetta ufficiale della Commissione europea):

Машина, указанная выше, полностью соответствует следующим регламентам ЕС/ЕУ (опубликованным в Официальном журнале Европейского Содружества):

1 / 3

BINDER GmbH  
Im Mittleren Ösch 5  
78502 Tuttlingen  
Deutschland

Tel: +49 (0) 74 62 / 20 05 - 0  
Fax: +49 (0) 74 62 / 20 05 - 100  
info@binder-world.com  
www.binder-world.com

Geschäftsführung:  
Dipl.-Ing. Peter M. Binder,  
Michael Binder-Pfaff, Peter Wimmer,  
Benjamin Jeuthe  
Amtsgericht Stuttgart, HRB 727150  
Sitz der Gesellschaft: Tuttlingen  
Ust.-ID.-Nr.: DE815021304

Kreissparkasse Tuttlingen  
IBAN: DE05 6435 0070 0000 0022 66  
SWIFT: SOLA DE 31TUT  
Deutsche Bank Tuttlingen  
IBAN: DE56 6537 0075 0213 8709 00  
SWIFT: DEUT DE 33853

- **2006/42/EC**  
Maschinenrichtlinie 2006/42/EG / Machinery directive 2006/42/EC / Directive Machines 2006/42/EC / Directiva 2006/42/CE (Máquinas) / Direttiva macchine 2006/42/CE / Директива о машинах 2006/42/EC
- **2014/30/EU**  
EMV-Richtlinie 2014/30/EU / EMC Directive 2014/30/EU / Directive CEM 2014/30/UE / Directiva CEM 2014/30/UE / Direttiva EMC 2014/30/UE / Директива ЭМС 2014/30/EU
- **2011/65/EU, (EU) 2015/863**  
RoHS-Richtlinien 2011/65/EU und (EU) 2015/863 / RoHS Directives 2011/65/EU and (EU) 2015/863 / Directives RoHS 2011/65/UE et (UE) 2015/863 / Directivas RoHS 2011/65/UE y (UE) 2015/863 / Direttive RoHS 2011/65/UE et (UE) 2015/863 / Директивы RoHS 2011/65/EU и (EU) 2015/863

Die oben beschriebenen Maschinen entsprechen aufgrund ihrer Konzipierung und Bauart sowie in der von uns in Verkehr gebrachten Ausführung den einschlägigen grundlegenden Sicherheits- und Gesundheitsanforderungen der genannten EG/EU-Richtlinien.

The machines described above are conform to the mentioned EC/EU directives in regard to the relevant safety and health demands due to their conception and style of construction as well as to the version put onto market by us.

Les machines décrites ci-dessus correspondent aux demandes de sécurité et de santé des directives citées de la CE/UE due à leur conception et construction et dans la réalisation mise sur le marché par nous.

Las máquinas descritas arriba se corresponden con los requisitos básicos pertinentes de seguridad y salud de las citadas directivas de la CE/UE debido a su concepción y fabricación, así como a la realización llevada a cabo por nosotros.

Le macchine sopra descritte sono conforme ai requisiti essenziali di sanità e sicurezza pertinenti delle summenzionate direttive CE/UE in termini di progettazione, tipo di costruzione ed esecuzione messa da noi in circolazione.

Машины описано выше, соответствует указанным директивам ЕС/EU в отношении требований соответствующей безопасности и здоровья по концепции и конструкции так же как и версия, применяемая нами на рынке.

Die oben beschriebenen Maschinen tragen entsprechend die Kennzeichnung CE.

The machines described above, corresponding to this, bear the CE-mark.

Les machines décrits ci-dessus, en correspondance, portent l'indication CE.

Las máquinas descritas arriba, en conformidad, llevan la indicación CE.

Le macchine sopra descritte sono contrassegnate dal marchio CE.

Машины описано выше, в соответствии с изложенным выше маркированы знаком CE.

Die oben beschriebenen Maschinen sind konform mit folgenden harmonisierten Normen:

The machines described above are in conformity with the following harmonized standards:

Les machines décrits ci-dessus sont conformes aux normes harmonisées suivantes:

Las máquinas descritas arriba cumplen con las siguientes normas:

Le macchine sopra descritte sono conforme alle seguenti normative armonizzate:

Машины описано выше, полностью соответствуют следующим стандартам:

2 / 3

2014/30/EU
<ul style="list-style-type: none"> <li>• <b>EN IEC 61326-1:2021</b></li> </ul>
2011/65/EU, (EU) 2015/863
<ul style="list-style-type: none"> <li>• <b>EN IEC 63000:2018</b></li> </ul>

Die oben beschriebenen Maschinen sind konform mit folgenden Prüfgrundlagen und Normen:  
 The machines described above are in conformity with the following test specifications and standards:  
 Les machines décrits ci-dessus sont conformes aux spécifications d'essai et normes suivantes:  
 Las maquinas descritas arriba cumplen con las siguientes especificaciones de prueba y normas:  
 Le macchine sopra descritte sono conforme alle seguenti specifiche di prova e normative:  
 Машины описано выше, полностью соответствуют следующим тестовыми базами и стандартам:

2006/42/EC
<ul style="list-style-type: none"> <li>• <b>Type Test Certificate NV 24234</b>, issued by DGUV Test on 27.11.2024 according to the testing principles GS-NV DGUV Test:2019/08 in accordance with <b>EN ISO 12100:2010, EN ISO 13732-1:2008, EN ISO 13732-3:2008, EN 60204-1:2018</b></li> </ul>
Zusätzlich angewandte Normen / Additionally applied standards / Normes supplémentaires appliquées / Normas aplicadas adicionalmente / Norme applicate in aggiunta / Дополнительно применяемые стандарты
<ul style="list-style-type: none"> <li>• <b>EN 61010-1:2010+A1:2019+A1:2019/AC:2019; IEC 61010-1:2010+A1:2016; UL 61010-1:2012 Ed.3+R:06Jun2023; CSA C22.2 No. 61010-1-12:2012 Ed.3+U1;U2;A1;U3</b></li> <li>• <b>EN IEC 61010-2-012:2022 + A11:2022; IEC 61010-2-012:2019 Ed.2; UL 61010-2-012:2022 Ed.2; CSA C22.2 No. 61010-2-012:2019 Ed.2</b></li> </ul>

78532 Tuttlingen, 16.12.2024  
 BINDER GmbH



**P. Wimmer**  
 Chief Technology Officer  
 Chief Technology Officer (CTO)  
 Directeur de la technologie  
 Director de la tecnología  
 Direttore tecnico  
 Главный технический директор



**J. Bollaender**  
 Leiter F & E und Dokumentationsbevollmächtigter  
 Director R & D and documentation representative  
 Chef de service R&D et autorisé de documentation  
 Responsable I & D y representante de documentación  
 Direttore R & D e responsabile della documentazione  
 Глава департамента R&D представитель документации

3 / 3

BINDER GmbH  
 Im Mittleren Ösch 5  
 78502 Tuttlingen  
 Deutschland

Tel: +49 (0) 74 62 / 20 05 - 0  
 Fax: +49 (0) 74 62 / 20 05 - 100  
 info@binder-world.com  
 www.binder-world.com

Geschäftsführung:  
 Dipl.-Ing. Peter M. Binder,  
 Michael Binder-Pfaff, Peter Wimmer,  
 Benjamin Jeuthe  
 Amtsgericht Stuttgart, HRB 727150  
 Sitz der Gesellschaft: Tuttlingen  
 Ust.-ID.-Nr.: DE815021304

Kreissparkasse Tuttlingen  
 IBAN: DE05 6435 0070 0000 0022 66  
 SWIFT: SOLA DE 31TUT  
 Deutsche Bank Tuttlingen  
 IBAN: DE56 6537 0075 0213 8709 00  
 SWIFT: DEUT DE 33653

## 27.2 UKCA Declaration of Conformity



UK CA		UKCA Declaration of Conformity	
Name and address of manufacturer	BINDER GmbH Im Mittleren Ösch 5, 78532 Tuttlingen, Germany		
Name and address of UK Authorised Representative	Comply Express Ltd Unit C2, Coalport House, Stafford Park 1, Telford TF3 3BD		
Object of the Declaration	Cooling incubators with compressor technology		
Type Designation	KB 65, KB 130, KB 260, KB 470, KB 720, KB 1060 (E7)		
BINDER Art. No.	9020-0471, 9120-0471, 9020-0472, 9120-0472, 9020-0473, 9120-0473, 9020-0474, 9120-0474, 9020-0475, 9120-0475, 9020-0476, 9120-0476		

The Objects of the Declaration described above are in conformity with the relevant UK Regulations and UK Guidelines:

- **Supply of Machinery (Safety) Regulations 2008**  
Statutory Instruments 2008 No. 1597 – Health and safety
- **Electromagnetic Compatibility Regulations 2016**  
Statutory Instruments 2016 No. 1091 – Electromagnetic Compatibility
- **The Restriction of the Use of Certain Hazardous Substances in Electrical and Electronic Equipment Regulations 2012**  
Statutory Instruments 2012 No. 3032 – Environmental Protection

References of standards and/or technical specifications applied for this Declaration of Conformity, or parts thereof:

<b>S.I. 2016 No. 1091:</b>	EN IEC 61326-1:2021
<b>S.I. 2012 No. 3032:</b>	EN IEC 63000:2018

The machines described above are in conformity with the following test specifications and standards:

S.I. 2008 No. 1597
• <b>Type Test Certificate NV 24234</b> , issued by DGUV Test on 27.11.2024 according to the testing principles GS-NV DGUV Test:2019/08 in accordance with EN ISO 12100:2010, EN ISO 13732-1:2008, EN ISO 13732-3:2008, EN 60204-1:2018
Additionally applied standards
• EN 61010-1:2010+A1:2019+A1:2019/AC:2019, EN IEC 61010-2-012:2022 + A11:2022

This Declaration is issued under the sole responsibility of the manufacturer.

Tuttlingen 16.12.2024

Place Date

P. Wimmer  
Chief Technology Officer

J. Bollaender  
Director R & D

BINDER GmbH

BINDER GmbH  
Im Mittleren Ösch 5  
78502 Tuttlingen  
Deutschland

Tel: +49 (0) 74 62 / 20 05 - 0  
Fax: +49 (0) 74 62 / 20 05 - 100  
info@binder-world.com  
www.binder-world.com

Geschäftsführung:  
Dipl.-Ing. Peter M. Binder  
Michael Binder-Pfaff, Peter Wimmer,  
Benjamin Jeulhe  
Amtsgericht Stuttgart, HRB 727150  
Sitz der Gesellschaft: Tuttlingen  
Ust.-ID.-Nr.: DE815021304

Kreissparkasse Tuttlingen  
IBAN: DE05 6435 0070 0000 0022 66  
SWIFT: SOLA DE 31TUT  
Deutsche Bank Tuttlingen  
IBAN: DE56 6537 0075 0213 8709 00  
SWIFT: DEUT DE 55653



## 27.3 Certificate for the GS mark of conformity of the “Deutsche Gesetzliche Unfallversicherung e.V.” (German Social Accident Insurance) DGUV

Zertifikat  
Nr. **NV 24233**  
vom 27.11.2024



### GS-Zertifikat

Name und Anschrift des  
Zertifikatsinhabers:  
(Auftraggeber)

**Binder GmbH**  
Im Mittleren Ösch 5  
78532 Tuttlingen

Produktbezeichnung:

**Klima- und Kühlbrutschrank**

Typ:

KB 65, KB 65-UL, KB 130, KB 130-UL, KB 260,  
KB 260-UL, KB 470, KB 470-UL, KB 720, KB 720-UL,  
KB 1060, KB 1060-UL,  
KB PRO 130, KB PRO 260, KB PRO 470, KB PRO 720,  
KB PRO 1060, KB PRO 1600,  
KBF 130, KBF 130-UL, KBF 260, KBF 260-UL, KBF 470,  
KBF 470-UL, KBF 720, KBF 720-UL, KBF 1060,  
KBF 1060-UL, KBF 1600, KBF 1600-UL,  
KBF PRO 130, KBF PRO 260, KBF PRO 470,  
KBF PRO 720, KBF PRO 1060, KBF PRO 1600

Prüfgrundlage:

GS-NV 5:2019/08 Prüfgrundsätze für Kühl- und Gefriermaschinen für  
Industrie und Gewerbe

Zugehöriger Prüfbericht:

Prüfbericht zum Zertifikat NV 24233

Weitere Angaben:

Das Zertifikat bezieht sich auf die im zugehörigen Prüfbericht be-  
schriebene Ausführung des Produkts.

Das geprüfte Baumuster stimmt mit den in § 20 Absatz 3 des Produktsicherheitsgesetzes  
genannten Anforderungen überein. Der Zertifikatsinhaber ist berechtigt, das umseitig abgebildete  
GS-Zeichen an den mit dem geprüften Baumuster übereinstimmenden Produkten anzubringen.  
Der Zertifikatsinhaber hat dabei die umseitig aufgeführten Bedingungen zu beachten.

Dieses Zertifikat einschließlich der Berechtigung zur Anbringung des GS-Zeichens ist gültig bis ein-  
schließlich:

**26.11.2029**

Weiteres über die Gültigkeit, eine Gültigkeitsverlängerung und andere Bedingungen regelt die Prüf-  
und Zertifizierungsordnung.



Unterschrift (Zertifizierer)

Rückseite GS-Zertifikat: NV 24233

### GS-Zeichen



Normalausführung



Bei einer Höhe von 20 mm oder weniger  
auch zulässige Ausführung

1. Der Zertifikatsinhaber hat die Voraussetzungen einzuhalten, die bei der Herstellung des umseitig genannten Produktes zu beachten sind, um die Übereinstimmung mit dem geprüften Baumuster zu gewährleisten.
2. Die Prüf- und Zertifizierungsstelle des Fachbereichs Nahrungsmittel führt in regelmäßigen Abständen Kontrollmaßnahmen zur Überwachung der Herstellung und rechtmäßigen Verwendung des GS-Zeichens durch.
3. Die für die Herstellung verantwortliche Person hat sich zur Einhaltung der Voraussetzungen nach Nummer 1 und Duldung der Kontrollmaßnahmen verpflichtet.
4. Die Prüf- und Zertifizierungsstelle entzieht dem Zertifikatsinhaber die Zuerkennung des GS-Zeichens, wenn sich die Anforderungen nach § 20 Absatz 3 Produktsicherheitsgesetz geändert haben oder die Voraussetzungen nach Nummer 1 nicht eingehalten werden.
5. Das GS-Zeichen darf nur verwendet und mit ihm darf nur geworben werden, wenn die Voraussetzungen nach § 24 Produktsicherheitsgesetz erfüllt sind.

## 28. Contamination clearance certificate

### 28.1 For chambers located outside USA and Canada

#### Declaration regarding safety and health

Erklärung zur Sicherheit und gesundheitlichen Unbedenklichkeit

The German Ordinance on Hazardous Substances (GefStofV), and the regulations regarding safety at the workplace, require that this form be filled out for all products that are returned to us, so that the safety and the health of our employees can be guaranteed

Die Sicherheit und Gesundheit unserer Mitarbeiter, die Gefahrstoffverordnung GefStofV und die Vorschriften zur Sicherheit am Arbeitsplatz machen es erforderlich, dass dieses Formblatt für alle Produkte, die an uns zurückgeschickt werden, ausgefüllt wird.



Note: A repair is not possible without a completely filled out form.

Ohne Vorliegen des vollständig ausgefüllten Formblattes ist eine Reparatur nicht möglich.

- A completely filled out form must be transmitted via Fax (+49 (0) 7462 2005 93555) or by letter in advance, so that this information is available before the equipment/component part arrives. A second copy of this form must accompany the equipment/component part. In addition, the carrier should be notified.

Eine vollständig ausgefüllte Kopie dieses Formblattes soll per Fax unter Nr. +49 (0) 7462 2005 93555 oder Brief vorab an uns gesandt werden, so dass die Information vorliegt, bevor das Gerät/Bauteil eintrifft. Eine weitere Kopie soll dem Gerät/Bauteil beigefügt sein. Ggf. ist die Spedition zu informieren.

- Incomplete information or non-conformity with this procedure will inevitably lead to substantial delays in processing. Please understand the reason for this measure, which lies outside our area of influence, and will help us to speed up this procedure.

Unvollständige Angaben oder Nichteinhalten dieses Ablaufs führen zwangsläufig zu beträchtlichen Verzögerungen in der Abwicklung. Bitte haben Sie Verständnis für Maßnahmen, die außerhalb unserer Einflussmöglichkeiten liegen und helfen Sie mit, den Ablauf zu beschleunigen.

- **Please print and fill out this form completely**

Bitte unbedingt vollständig ausfüllen!

<b>1.</b>	<b>Unit/ component part / type</b> / Gerät / Bauteil / Typ:
<b>2.</b>	<b>Serial No.</b> / Serien-Nr.:
<b>3.</b>	<b>Details about utilized substances / biological substances</b> / Einzelheiten über die eingesetzten Substanzen/biologische Materialien:
<b>3.1</b>	<b>Designations</b> / Bezeichnungen:
a)	_____
b)	_____
c)	_____
<b>3.2</b>	<b>Safety measures required for handling these substances</b> / Vorsichtsmaßnahmen beim Umgang mit diesen Stoffen:
a)	_____
b)	_____
c)	_____

<b>3.3</b>	<b>Measures to be taken in case of skin contact or release into the atmosphere</b> / Maßnahmen bei Personenkontakt oder Freisetzung: a) _____ b) _____ c) _____ d) _____
<b>3.4</b>	<b>Other important information that must be taken into account</b> / Weitere zu beachtende und wichtige Informationen: a) _____ b) _____ c) _____
<b>4.</b>	<b>Declaration on the risk of these substances</b> (please checkmark the applicable items) / Erklärung zur Gefährlichkeit der Stoffe (bitte Zutreffendes ankreuzen) : <input type="checkbox"/> <b>4.1 For non toxic, non radioactive, biologically harmless materials</b> / für nicht giftige, nicht radioaktive, biologisch ungefährliche Stoffe: <b>We hereby guarantee that the above-mentioned unit / component part...</b> / Wir versichern, dass o.g. Gerät/Bauteil... <input type="checkbox"/> Has not been exposed to or contains any toxic or otherwise hazardous substances / weder giftige noch sonstige gefährliche Stoffe enthält oder solche anhaften. <input type="checkbox"/> That eventually generated reaction products are non-toxic and also do not represent a hazard / auch evtl. entstandene Reaktionsprodukte weder giftig sind noch sonst eine Gefährdung darstellen. <input type="checkbox"/> Eventual residues of hazardous substances have been removed / evtl. Rückstände von Gefahrstoffen entfernt wurden. <input type="checkbox"/> <b>4.2 For toxic, radioactive, biologically harmful or hazardous substances, or any other hazardous materials</b> / für giftige, radioaktive, biologisch bedenkliche bzw. gefährliche Stoffe oder anderweitig gefährliche Stoffe. <b>We hereby guarantee that ...</b> / Wir versichern, dass ... <input type="checkbox"/> The hazardous substances, which have come into contact with the above-mentioned equipment / component part, have been completely listed under item 3.1 and that all information in this regard is complete / die gefährlichen Stoffe, die mit dem o.g. Gerät/Bauteil in Kontakt kamen, in 3.1 aufgelistet sind und alle Angaben vollständig sind. <input type="checkbox"/> That the unit /component part has not been in contact with radioactivity / das Gerät/Bauteil nicht mit Radioaktivität in Berührung kam
<b>5.</b>	<b>Kind of transport / transporter</b> / Transportweg/Spediteur:  Transport by (means and name of transport company, etc.) Versendung durch (Name Spediteur o.ä.) _____ _____ Date of dispatch to BINDER GmbH / Tag der Absendung an BINDER GmbH: _____ _____



**We hereby declare that the following measures have been taken / Wir erklären, dass folgende Maßnahmen getroffen wurden:**

- Hazardous substances were removed from the unit including component parts, so that no hazard exists for any person in the handling or repair of these items / das Gerät/Bauteil wurde von Gefahrstoffen befreit, so dass bei Handhabung/Reparaturen für die betreffenden Person keinerlei Gefährdung besteht
- The unit was securely packaged and properly identified / das Gerät wurde sicher verpackt und vollständig gekennzeichnet.
- Information about the hazardousness of the shipment (if required) has been provided to the transporter / der Spediteur wurde (falls vorgeschrieben) über die Gefährlichkeit der Sendung informiert.

We hereby commit ourselves and guarantee that we will indemnify BINDER GmbH for all damages that are a consequence of incomplete or incorrect information provided by us, and that we will exempt BINDER GmbH from eventual damage claims by third parties./ Wir versichern, dass wir gegenüber BINDER für jeden Schaden, der durch unvollständige und unrichtige Angaben entsteht, haften und BINDER gegen eventuell entstehende Schadensansprüche Dritter freistellen.

We are aware that, in accordance with Article 823 of the German Civil Code (BGB), we are directly liable with regard to third parties, in this instance especially the employees of BINDER GmbH, who have been entrusted with the handling / repair of the unit / component. / Es ist uns bekannt, dass wir gegenüber Dritten – hier insbesondere mit der Handhabung/Reparatur des Geräts/des Bauteils betraute Mitarbeiter der Firma BINDER - gemäß §823 BGB direkt haften

Name: \_\_\_\_\_

Position/ Title: \_\_\_\_\_

Date / Datum: \_\_\_\_\_

Signature / Unterschrift: \_\_\_\_\_

Company stamp / Firmenstempel:



Equipment that is returned to the factory for repair must be accompanied by a completely filled out contamination clearance certificate. For service and maintenance on site, such a contamination clearance certificate must be submitted to the service technician before the start of any work. No repair or maintenance of the equipment is possible, without a properly filled out contamination clearance certificate.

## 28.2 For chambers located in USA and Canada

### Product Return Authorization Request

Please complete this form and the Customer Decontamination Declaration (next 2 pages) and attach the required pictures. E-mail to: IDL\_SalesOrderProcessing\_USA@binder-world.com

After we have received and reviewed the complete information we will decide on the issue of a RMA number. Please be aware that size specifications, voltage specifications as well as performance specifications are available on the internet at [www.binder-world.us](http://www.binder-world.us) at any time.

Take notice of shipping laws and regulations.

	Please fill:	
Reason for return request	<input type="radio"/> Duplicate order	
	<input type="radio"/> Duplicate shipment	
	<input type="radio"/> Demo	<i>Page one completed by sales</i>
	<input type="radio"/> Power Plug / Voltage	115V / 230 V / 208 V / 240V
	<input type="radio"/> Size does not fit space	
	<input type="radio"/> Transport Damage	Shock watch tripped? ( <i>pictures</i> )
	<input type="radio"/> Other (specify below)	
	_____	
Is there a replacement PO?	<input type="radio"/> Yes <input type="radio"/> No	
<i>If yes -&gt; PO #</i>		
<i>If yes -&gt; Date PO placed</i>		
Purchase order number		
BINDER model number		
BINDER serial number		
Date unit was received		
Was the unit unboxed?	<input type="radio"/> Yes <input type="radio"/> No	
Was the unit plugged in?	<input type="radio"/> Yes <input type="radio"/> No	
Was the unit in operation?	<input type="radio"/> Yes <input type="radio"/> No	
<i>Pictures of unit attached?</i>	<input type="radio"/> Yes <input type="radio"/> No	Pictures have to be attached!
<i>Pictures of Packaging attached?</i>	<input type="radio"/> Yes <input type="radio"/> No	

	Customer Contact Information	Distributor Contact Information
Name		
Company		
Address		
Phone		
E-mail		

## Customer (End User) Decontamination Declaration

### Health and Hazard Safety declaration

To protect the health of our employees and the safety at the workplace, we require that this form is completed by the user for all products and parts that are returned to us. (Distributors or Service Organizations cannot sign this form)



NO RMA number will be issued without a completed form. Products or parts returned to our NY warehouse without an RMA number will be refused at the dock.

A second copy of the completed form must be attached to the outside of the shipping box.

<b>1.</b>	<b>Unit/ component part / type:</b>
<b>2.</b>	<b>Serial No.</b>
<b>3.</b>	<b>List any exposure to hazardous liquids, gasses or substances and radioactive material</b>
<b>3.1</b>	<b>List with MSDS sheets attached where available or needed (if there is not enough space available below, please attach a page):</b>
a)	_____
b)	_____
c)	_____
<b>3.2</b>	<b>Safety measures required for handling the list under 3.1</b>
a)	_____
b)	_____
c)	_____
<b>3.3</b>	<b>Measures to be taken in case of skin contact or release into the atmosphere:</b>
a)	_____
b)	_____
c)	_____
d)	_____
<b>3.4</b>	<b>Other important information that must be considered:</b>
a)	_____
b)	_____
c)	_____

**4. Declaration of Decontamination**

**For toxic, radioactive, biologically and chemically harmful or hazardous substances, or any other hazardous materials.**

**We hereby guarantee that**

- 4.1 Any hazardous substances, which have come into contact with the above-mentioned equipment / component part, have been completely listed under item 3.1 and that all information in this regard is complete.
- 4.2 That the unit /component part has not been in contact with radioactivity
- 4.3 Any Hazardous substances were removed from the unit / component part, so that no hazard exists for a person in the shipping, handling or repair of these returned unit
- 4.4 The unit was securely packaged in the original undamaged packaging and properly identified on the outside of the packaging material with the unit designation, the RMA number and a copy of this declaration.
- 4.5 Shipping laws and regulations have not been violated.

**I hereby commit and guarantee that we will indemnify BINDER Inc. for all damages that are a consequence of incomplete or incorrect information provided by us, and that we will indemnify and hold harmless BINDER Inc. from eventual damage claims by third parties.**

Name: \_\_\_\_\_

Position: \_\_\_\_\_

Company: \_\_\_\_\_

Address: \_\_\_\_\_

Phone #: \_\_\_\_\_

Email: \_\_\_\_\_

Date: \_\_\_\_\_

Signature: \_\_\_\_\_



Equipment returned to the NY warehouse for repair must be accompanied by a completed customer decontamination declaration. For service and maintenance works on site, such a customer decontamination declaration must be submitted to the service technician before the start of work. No repair or maintenance of the equipment is possible without a completed form.

